

WEST CONCORD, MASSACHUSETTS

GENERAL RADIO COMPANY

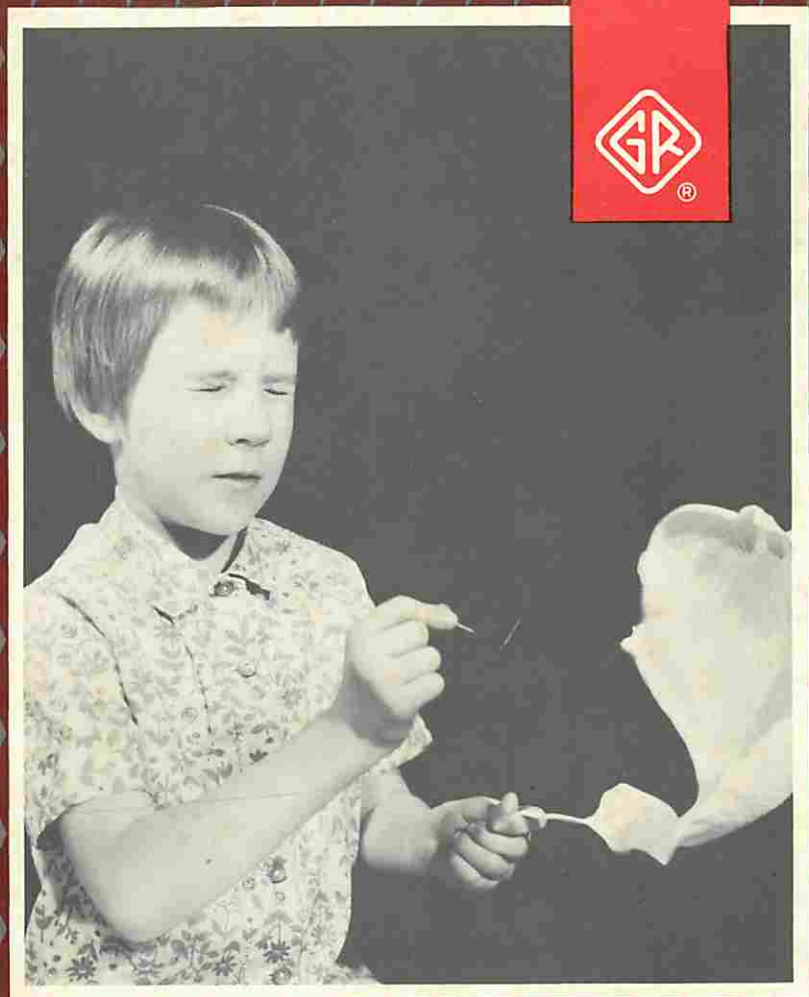

HANDBOOK  
OF  
**High-Speed**  
**PHOTOGRAPHY**



# HANDBOOK OF *High-Speed* PHOTOGRAPHY

SECOND EDITION  
(Revised)

by  
Charles E. Miller



on the cover

A pin struck balloon. Photo taken using a 4 x 5 camera loaded with Kodak Tri-X film. Exposure data: two 1532 Strobolumes, 45-degree lighting, set back 8 feet from subject; camera set to f/11. A microphone picked up the sound of the burst and triggered the flash in a darkened room. No synchronization; camera shutter opened and closed manually just before and after burst.

GENERAL RADIO COMPANY  
WEST CONCORD • MASSACHUSETTS • USA

Copyright 1963 and 1967, by General Radio Company, West Concord, Mass., U.S.A.

# TABLE OF CONTENTS

ACKNOWLEDGEMENT .....	iii
FOREWORD .....	iv
SECTION 1. INTRODUCTION.....	1
1.1 Stopping Action with a Short Exposure Time .....	1
1.2 Multiple-Exposure Motion Studies with a Strobotacmeter .....	2
1.3 Using the Stroboscope with Moving Film .....	8
SECTION 2. CHARACTERISTICS OF STROBOSCOPES .....	9
2.1 Introduction .....	9
2.2 Using the Tables .....	9
2.3 Flash Intensity Versus Duration.....	12
2.4 Timing in High-Speed Photography.....	13
2.5 A Specific Example .....	13
SECTION 3. GENERAL RADIO STROBOSCOPES .....	16
3.1 The Type 1539 Stroboslave <sup>®</sup> electronic stroboscope .....	16
3.2 The Type 1531 Strobotac <sup>®</sup> electronic stroboscope.....	18
3.3 The Type 1538 Strobotac <sup>®</sup> electronic stroboscope.....	21
3.4 The Type 1540 Strobolume <sup>®</sup> electronic stroboscope .....	23
SECTION 4. STILL PHOTOGRAPHY .....	25
4.1 General .....	25
4.2 The Output Characteristics of General Radio Stroboscopes.....	25
4.3 Film Choice .....	28
4.4 Guide Number Chart .....	30
4.5 Lighting Techniques .....	32
4.6 Shadowgraph Photography with a Scotchlite Screen.....	34
4.7 Ambient Light Conditions .....	35
4.8 Operation of Camera Shutter at High Speeds.....	38
SECTION 5. SYNCHRONIZATION .....	41
5.1 General .....	41
5.2 Recognizing the Event: Various Means of Triggering the Synchronization Sequence .....	41
5.3 Processing the Trigger Signal .....	48
5.4 Taking a Typical High-Speed Photograph .....	55
SECTION 6. MOTION-PICTURE PHOTOGRAPHY .....	58
6.1 Use of a Movie Camera.....	58
6.2 Conventional Movie Cameras .....	58
6.3 High-Speed Movie Cameras .....	61
6.4 Movie Camera Synchronization .....	63
6.5 Selecting a Camera .....	65
PHOTOGRAPHS.....	66
BIBLIOGRAPHY.....	81
INDEX .....	84
CATALOG SECTION .....	86

# **ACKNOWLEDGMENT**

## **SECOND EDITION**

Of the many people who contributed to this second edition, the author would particularly like to thank Richard A. Jokinen for his considerable editorial efforts. Dr. Harold E. Edgerton of M.I.T. has provided continuing encouragement and assistance, as well as many of the photographic illustrations. The author would also like to thank Mr. David B. Eisendrath of New York City for his helpful suggestions, and the other friends and customers of General Radio who provided us with many of the interesting high-speed photos.

C. E. Miller  
General Radio Company  
June, 1967

# FOREWORD

When I first heard about high-speed photography only a few, perhaps a dozen, were fortunate enough to use the technique. The main use was in the study of ballistics and shock waves. All of this work followed directly from the splendid research of Mach more than one hundred years ago. He used spark gaps to produce light from a small volume to expose silhouette photographs of bullets and shock waves directly onto hand-made glass plates.

The day has now arrived when high-speed photography as a research tool is commonplace. This book is to introduce high-speed photography to the masses. Not only will the elaborate research laboratories of our day use the method but almost everyone will. It is symbolic that high-school students today are doing involved experimental research that would have been considered very difficult only a few years ago. The tempo of our time is fulfilled. The new generation arises with skills and techniques that those of the older generation did not, or could not, exploit.

The perfection of the new xenon FX-6A flash lamp by Kenneth Germeshausen and his collaborators, among whom I consider it a joy to be included, has aided in bringing the new Strobotac® electronic stroboscope to a form and performance where increased use is obtained. A paralleling development of the circuits and packaging by Michael Fitzmorris and Malcolm Holtje of General Radio Company, together with the cooperation of many of the staff of that company, has resulted in the unique instrument whose use for photography is described in detail in the following pages.

Developments in photography have contributed to the use of the Strobotac as a practical device for high-speed photography. Of special interest is the Polaroid-Land photography system which permits the almost immediate inspection of the end result. Then another picture can be taken at once to correct a fault or to improve the photography. Not only the Polaroid system, but photography in general with its many aspects can be used in many ways with the flashes of light from the Strobotac.

The advent of this book, then, marks a new era which brings the high-speed photographic system of experimental research into the reach of everyone. I foresee great results when we can "see" and "understand" the many now mysterious and unknown things that whirl and buzz about us. There is still need for new techniques and results. Let us hear from you.

Harold E. Edgerton

## section 1

# INTRODUCTION

### 1.1 STOPPING ACTION WITH A SHORT EXPOSURE TIME.

It is possible, using the fastest mechanical between-the-lens shutters or conventional photoflash units, to obtain exposure times down to 1/1000 second. Such exposure speeds are adequate for stopping the motion of ordinary events, such as a photo-finish at the race track or the leap of a ballet dancer, but are not fast enough to prevent blurring in photographs of extremely high-speed events. However, by using a strobe light, exposure times as small as a fraction of a microsecond and intensities of millions of beam candles can be realized. Such a brilliant, extremely brief light is generated by passing an electrical spark of several-thousand amperes through Xenon gas. The gas intensifies the spark and produces a light spectrum similar to that of daylight. Figure 1-1 is a table showing the effects of exposure time on photographic blur vs subject velocity.

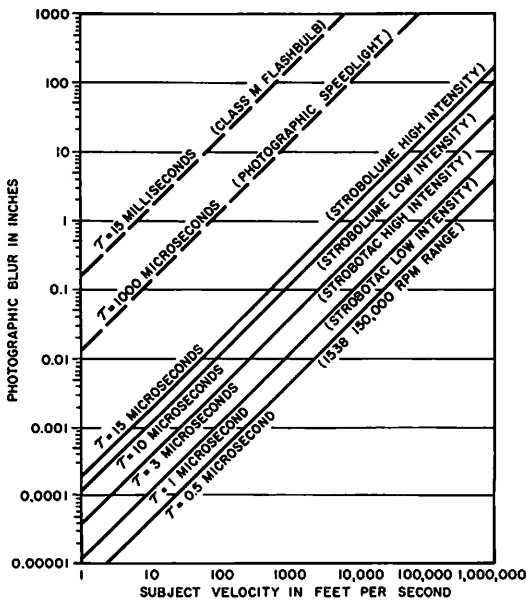

Figure 1-1. Photographic blur *vs* velocity and exposure time.

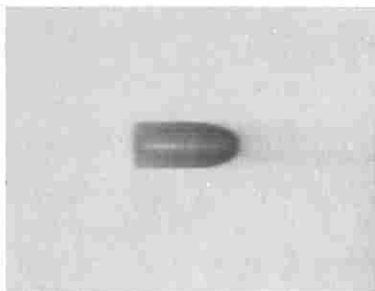

Figure 1-2. A .22-calibre rifle bullet photographed in flight. The faint gray streak extending in front of the bullet along its path is exposure resulting from flash-lamp afterglow. A single, high-intensity flash of the Strobotac was triggered with a microphone to stop the projectile's 1100-feet-per-second velocity. (Polaroid Type 47 film, ASA 3000, 3-microsecond exposure at  $f/22$ . The reflector was removed from the lamp.)

Suppose, for example, a photograph is required of a .22-calibre rifle bullet in flight. The bullet travels about 1100 feet per second. During the 1-millisecond exposure produced by a mechanical shutter the bullet travels about 13 inches. During the 80-microsecond exposure of a high-speed movie camera, it moves about one inch, still too far for good photographic resolution. Needed for this and similar applications is an exposure time of a few microseconds. In 3.0 microseconds, for instance, the bullet travels only 0.04 inch (see Figure 1-2). An excellent example of what is possible using a single-flash of a few microseconds duration is the series of photographs of a milk drop splashing on a hard surface shown in Figure 1-3. For other examples, refer to the photo section near the end of this book. For explanation of the methods used to produce such pictures refer to Sections 4 and 5.

## 1.2 MULTIPLE-EXPOSURE MOTION STUDIES WITH A STROBOTACHMETER.

Often the study of the relationship between events occurring in rapid succession calls for a means of making a series of high-speed photographs in a very short time. Usually a series of single flash photographs is prohibitively difficult to obtain or will not really show what is happening. A method which is easy and which results in clear representation of many high-speed actions is the multiple-flash exposure of a single film frame.

For example, suppose an engineer wants to determine the angular velocity and acceleration of a rotating shaft so that he can calculate the transient characteristics of the load being driven by the shaft. This data would be easy to collect if the engineer had a source of short-duration light flashes (short enough to stop the motion of the shaft) that would repeat at equally spaced and known time intervals.

Figure 1-3. These jewelled crowns, which show a drop of milk splashing on a hard surface, were made with the light of precisely timed flashes from a Strobotac<sup>®</sup> electronic stroboscope.

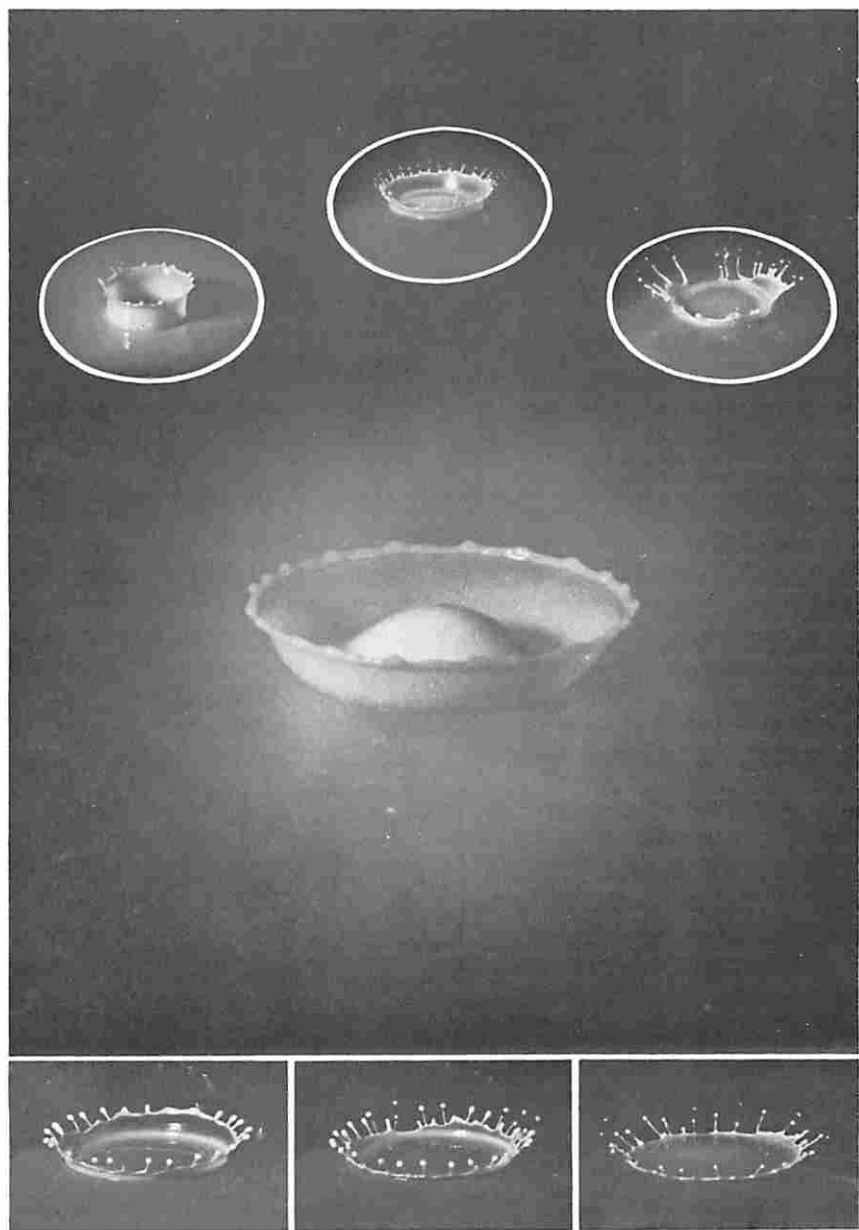
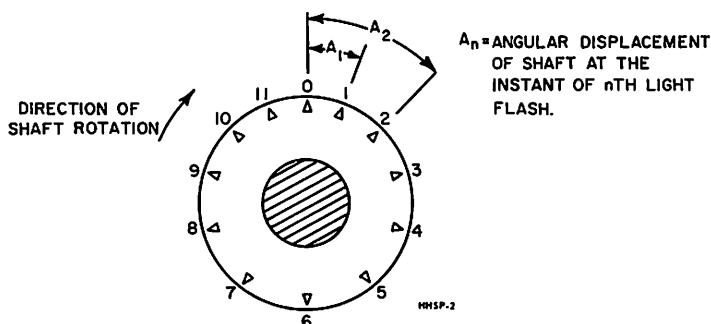



Figure 1-4. Multiple-flash analysis of shaft rotational motion.



Typical pattern obtained from a multiple-flash photograph of the end of a moving shaft. A single bright mark placed on the shaft's periphery reveals its position at the instant each Strobotac flash occurs.

Given: Average angular velocity = 1800 rpm =  $10.8^\circ$  per millisecond  
 Strobotac flash rate = 21,600 flashes per minute = 12 flashes per revolution

$t_p$  = time between Strobotac flashes = 2.78 milliseconds

Camera shutter speed approximately 1/30 second

To determine the shaft's average angular velocity at different positions, measure the angles between adjacent mark positions on the photograph and divide by  $t_p$ . Consider this average value over each displacement interval as the approximate angular velocity at the midpoint of the interval. Since this example is symmetrical, only half of the calculations need be made. For example:

Angles Measured From Photograph	Average Angular Velocity In Degrees Per Millisecond ( $\text{Angle}/t_p$ )	Shaft Displacement At Midpoint Of Interval
$A_1, (360-A_{11}) = 21^\circ$	$\bar{\omega}_{1,0} = 7.55$	$10^\circ, 350^\circ$
$(A_2-A_1), (A_{11}-A_{10}) = 24^\circ$	$\bar{\omega}_{2,1} = 8.63$	$33^\circ, 327^\circ$
$(A_3-A_2), (A_{10}-A_9) = 28^\circ$	$\bar{\omega}_{3,2} = 10.1$	$59^\circ, 301^\circ$
$(A_4-A_3), (A_9-A_8) = 32^\circ$	$\bar{\omega}_{4,3} = 11.5$	$89^\circ, 271^\circ$
$(A_5-A_4), (A_8-A_7) = 36^\circ$	$\bar{\omega}_{5,4} = 12.9$	$123^\circ, 237^\circ$
$(A_6-A_5), (A_7-A_6) = 39^\circ$	$\bar{\omega}_{6,5} = 14.0$	$160^\circ, 200^\circ$

Figure 1-4 (Continued)

Angular acceleration may be computed in a similar fashion from these angular velocity data points, e.g.:

Angular Acceleration (Degrees Per Millisecond <sup>2</sup> )	Shaft Displacement Midway Between Data Points
$(W_{1,0} - W_{12,11})/t_p =$	0
$(W_{2,1} - W_{1,0})/t_p =$	0.39
$(W_{3,2} - W_{2,1})/t_p =$	0.53
$(W_{4,3} - W_{3,2})/t_p =$	0.50
$(W_{5,4} - W_{4,3})/t_p =$	0.50
$(W_{6,5} - W_{5,4})/t_p =$	0.40
$(W_{7,6} - W_{6,5})/t_p =$	0
$(W_{8,7} - W_{7,6})/t_p =$	-0.40
	218° etc.

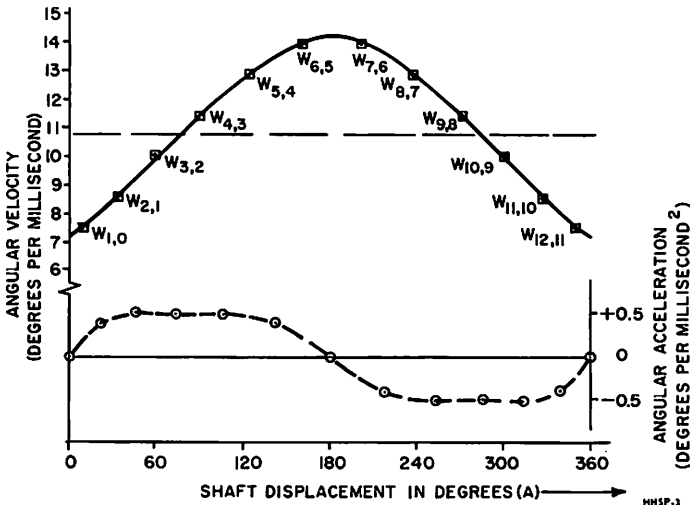

From the measured distance between successive positions of a fixed point on the shaft in a multiple exposure taken with such a light source, he could calculate the instantaneous velocity and acceleration of the shaft. Details of a sample problem and corresponding calculations are shown in Figure 1-4. For a description of the method used to take a multiple-flash picture, refer to paragraph 5.3.3.

An instrument capable of producing the flashes described is a stroboscope or a strobotachometer. Such equipment has been available commercially for many years, and is standard equipment for visual motion analysis in many industries that use machinery with rapidly moving parts. The stroboscope also has many applications in science and education, sports and advertising. Multiple-exposure pictures of the basic motions of various athletic feats, such as the swing of a golf club or the release of an arrow from a bow, have proven to be most instructive. Some noteworthy examples of this technique may be seen in the book *Flash! Seeing the Unseen by Ultra High-Speed Photography* by Edgerton and Killian (refer to Bibliography). Multiple-flash exposures have also proven their worth to advertisers who have used them to lend eye-catching appeal to illustrations that would otherwise have been run-of-the-mill. An example of this technique is shown in Figure 1-5.

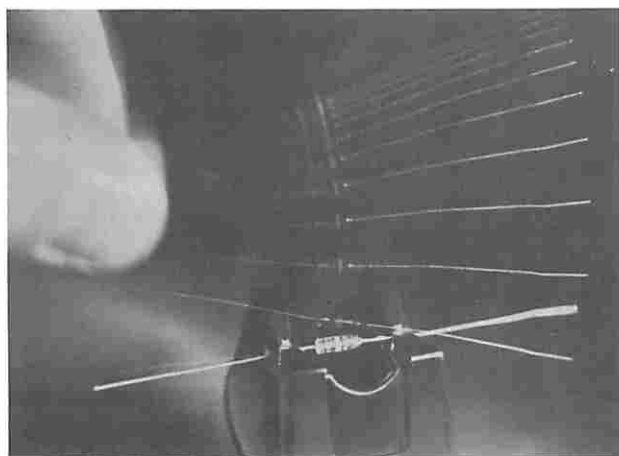

(Photograph courtesy of Daymarc Corporation, Waltham, Massachusetts)

Figure 1-5. Multiflash photograph of a semiconductor diode being attracted to a magnetic Daymarc Diode Clip.

Figure 1-6. Dynamic redistribution of stress in a rock model undergoing fracture.

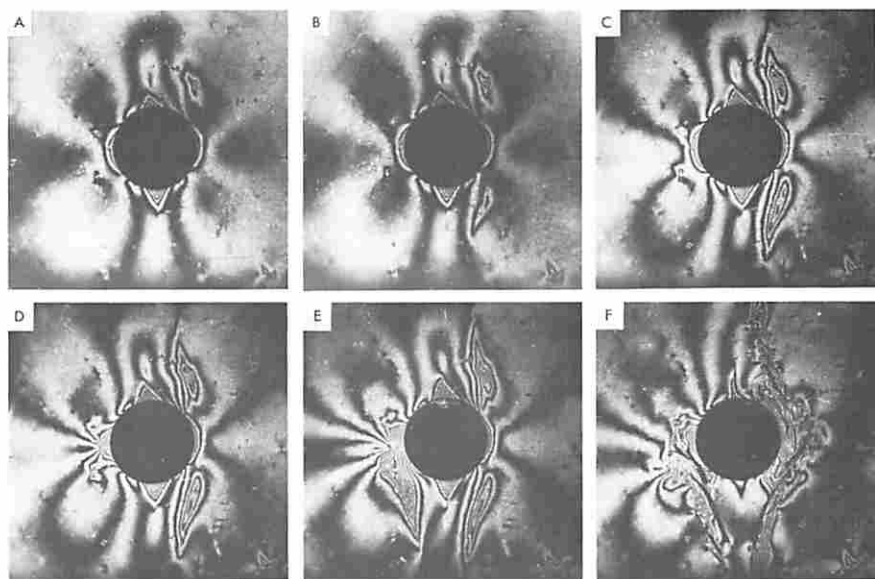

(Photographs courtesy of E. Hoek, National Mechanical Engineering Research Institute, Pretoria, South Africa.)

A series of multiple-flash, moving-film, high-speed photographs taken with the Strobotac electronic stroboscope to show the dynamic redistribution of stress in a rock model undergoing fracture. The model is a 5-inch-square rock plate,  $\frac{1}{4}$ -inch thick, with a  $\frac{3}{4}$ -inch-diameter circular hole in the center. It was subjected to vertical stresses ranging from 33,000 lb/sq in. in (a) to 40,000 lb/sq in. in (e) and (f). The lateral stress was held at 0.15 the value of the vertical stress.

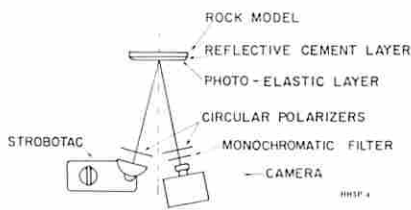

The strain patterns were photographed by the birefringent layer technique in which a layer of photo-elastic plastic is bonded onto the surface of the model with a reflective cement. The photo-elastic pattern induced in the layer by strain in the model is then analyzed with reflected polarized light. The monochromatic filter shown in the diagram was a Wratten 77, which passes light of 5461 angstrom units.

These photographs were taken on Ilford HP3 35-mm film (ASA 160) with a Leica Summicron 50-mm lens set at  $f/2$ . The Strobotac was set at 300 flashes per minute (3-microsecond exposure), and the film was transported past the lens at 5 inches per second with an oscillograph camera. No shutter was used. Both the camera and the Strobotac were approximately three feet from the subject, as shown in the sketch.

### 1.3 USING THE STROBOSCOPE WITH MOVING FILM.

It is impossible to study some complex motions using the multiple-exposure technique. This is especially so when the motion is confined to a small area or is characterized by a change of shape rather than a translational motion, that is, the subject does not "get out of its own way" to permit the photographing of separate and discreet successive images. For example, the changing stress patterns in a sample of material (see Figure 1-6). Studies of this type can be made by means of a high-speed motion picture camera, such as the Hycam, Fastax, etc., and a stroboscope. These cameras can move film past the camera lens at a high rate of speed so that thousands of frames per second can be exposed. The series of pictures produced by this method will display successive phases of a single cycle of the studied motion.

The stroboscope is also a very useful light source for use with high-speed movie cameras. The short duration flash of the stroboscope stops motion that would normally be blurred even when photographed by the fastest of movie cameras, as would the motion of a high-speed projectile. This improvement is especially advantageous where frame-by-frame analysis of the film must be made. For a more detailed description of the use of a stroboscopic light sources with moving-film devices, refer to Section 6.

The stroboscope can also be used to advantage in photographing heat-sensitive subjects, e.g., biological specimens. The stroboscope, due to its extremely low duty cycle or "on" time, is a relatively cool source of light.

## **section 2**

# **CHARACTERISTICS OF STROBOSCOPES**

## **2.1 INTRODUCTION**

Several different types of stroboscopic light sources representing a wide range of characteristics and a wide range of prices are available to the high-speed photographer. The principal specified characteristics of a stroboscope are: flash duration, repetition frequency, and light output. Other considerations are: means of triggering, type of trigger delay available, power required, physical dimensions (as they affect portability), and economy. The type of stroboscope a photographer chooses naturally depends on the type of picture he wants to take. In order to aid him in making this choice, the following paragraphs, in conjunction with Tables 2-1 and 2-2, indicate which type of stroboscope is best suited for each of various categories of high-speed photography.

## **2.2 USING THE TABLES.**

Table 2-1 lists the desirable characteristics of light sources corresponding to many applications of the stroboscope in high-speed photography. All values given in the table are approximate; exact light requirements depend on the individual picture-taking situation. In many cases, the values listed can be exceeded; that is, a faster, brighter, more expensive light source than called for can be used, so that the instrument obtained for the toughest job will do the lesser ones as well. This is not true under all circumstances, however, as the faster, more complicated instruments are more highly specialized. For example, the EG&G Type 2307 Double Flash Light Source is specifically designed for one application -- measuring velocities -- and its use is not practical for any other purpose.

TYPE OF APPLICATION	REQUIREMENTS				
	Flash Duration	Flashes per sec	Relative Intensity	Trigger	Delay* (Time) Method
Single Flash					
Illumination for portraits and other non high-speed photography (people and other slow objects)	1/1000 s (1 ms)	—	High	Manual or Sync'd to camera (open or close switch)	(1/25 s) Visual
High-speed photography (birds' wings, breaking light bulbs)	10-100 $\mu$ s	—	Medium to High	Manual or Sync'd to event by electrical, acoustical, optical or mechanical means	Electronic if any
Ultra-high-speed photography (bullets in flight, shock-waves, high-speed machinery)	1 $\mu$ s	—	Low to Medium	Electronically sync'd to event by signal from microphone, photocell, etc.	(1-100 ms) Electronic
Multiple Flash					
"Untimed" multiple exposure (sports, advertising, educational demonstrations) where precise timing unnecessary	100 $\mu$ s	100	High	Internal oscillator, electronic signal from contactor, photoelectric pickup, etc.	Visual
Precision measurements, Single frame High-speed Ultra-high speed	1-10 $\mu$ s 1 $\mu$ s	500 1000	Low to Medium	Pulses from calibrated internal oscillator, contactor, or other externally generated signal	Electronic
Moving film, flashes not synchronized	1-100 $\mu$ s	400	Medium to High	Pulses from oscillator or contactor	—
Moving film, flashes synchronized with camera	1-100 $\mu$ s	400	Medium to High	Closed switch	—
Precision motion studies (explosions, projectiles, vibrations)	1-10 $\mu$ s	100 1000	Low to Medium	Calibrated oscillator	—

\*Refers to the delay between the input signal and the firing of the flash; thus, visual delay means that the delay between the occurrence of the event and the flash depends on the photograph.

TABLE 2-1.

Table 2-2 lists the characteristics of several commercially available stroboscopes in a form that facilitates comparison of these characteristics with those required in Table 2-1. The reader may notice that there is no strobe in the tables that satisfactorily answers the need for

Comparison of Various Features of Some General-Purpose Stroboscopes

Light Source	Approximate Price	Duration $\mu$ s	Max Repetition Freq flashes/sec	Energy/flash Joules or Watt-seconds	Light (million beam candelas)	Time Delay
GR Type 1539 Stroboslave <sup>®</sup> electronic stroboscope	\$230	0.8 to 3.0	600 to 800	0.6-18	0.48 to 33	external only 100 $\mu$ s to 1 s, uncalibrated, with Type 1531-P2
GR Type 1531 Stroboslave <sup>®</sup> electronic stroboscope	\$545	0.8 to 3.0	600 to 800 (has internal oscillator for up to 400 1/s calibrated)	0.6 to 18	0.48 to 33	external only 100 $\mu$ s to 1 s, uncalibrated, with Type 1531-P2
GR Type 1538 Stroboslave <sup>®</sup> electronic stroboscope	\$545	0.5 to 3.0 (8.0 with 1538-P4)	(has internal oscillator for up to 3000 1/s calibrated)	0.1 to 18 (44 with 1538-P4)	0.8 to 45 (352 with Type 1538-P4 Capacitor)	external only 100 $\mu$ s to 1 s, uncalibrated, with Type 1531-P2
GR Type 1540 Strobolume electronic stroboscope	\$775 to \$975	10 to 15	600 to 800 (400 1/s calibrated)	0.25 to 10	0.47 to 16.7	100 $\mu$ s to 1 s, uncalibrated, with 1540-P4
EG&G Model 553 Multi Flash Srobe	\$1760	25 40	120 cps in bursts to 1.5 s	6 12	150-400 bcp <sup>a</sup>	external only
EG&G Model 549 Microflash	\$1250	0.5	0.2	6.5	50	adjustable, uncalibrated, 3-1000 $\mu$ s
EG&G Model 502 Multiple Microflash Unit	\$5700 & \$600 per flash	1	25 - 100,000 in bursts of up to 20 flashes (has internal oscillator)	1.5	0.2	between flashes adjustable 10 - 40 $\mu$ s
EG&G Type 501 High-Speed Stroboscope For 0.01 $\mu$ F capacitor in input circuit -- For 0.04 $\mu$ F capacitor in input circuit	\$6555	1.2	6000 in bursts of up to 0.8 s	0.3	0.16	external only
		2.1	800 in bursts of up to 1.5 s (has internal osc.)	1.3	0.84	

Note: The Type 1538 Stroboslave is completely portable, as it has a battery-powered option. The Type 1531 and Type 1539 are portable but require a power cord.

The Type 1540 can be carried, but is mainly a studio light source. The Type 1531-P2 Flash Delay can be used with a Type 1536 Photoelectric Pickoff for optical triggering.

<sup>a</sup> Depending on beam angle.

TABLE 2-2.

a single-flash light source for photography of "people and other slow objects." This is because what is needed in this case is not really a stroboscope, but a speedlight, an essentially single-flash instrument used mainly for nontechnical photographic work. For information on this type of instrument, consult the *KODAK Reference Handbook* (refer to Bibliography). Most of the stroboscopes in Table 2-2 are designed for precise industrial and scientific high-speed photography, although the GR Type 1539 Stroboslave, which is small, lightweight, conveniently triggered, and inexpensive, may prove to be just the thing for the photographer who wants more speed (shorter flash durations) and higher repetition frequencies than a speedlight can give.



### 2.3 FLASH INTENSITY VERSUS DURATION.

The photographer may have to compromise when choosing an instrument for very high-speed applications since, as a glance at Table 2-2 will prove, the greater the intensity of an instrument's flash, the longer the duration and, the lower the flash frequency rate. For example, the EG&G Model 549 Microflash has a high-intensity submicrosecond flash, and this is at the expense of repetition frequency. About fifty times faster, but with one fifth the intensity and six times the duration, are the flashes of the General Radio Type 1531 and Type 1538 Strobotac electronic stroboscopes. A number of these instruments may be flashed in succession if a burst of high-intensity flashes with high repetition frequency is required. (Refer to paragraph 5.3.3). Figure 2-1 is a picture taken with such an arrangement. If light intensity, not speed, is the main concern, the General Radio Strobolume is probably the best choice.

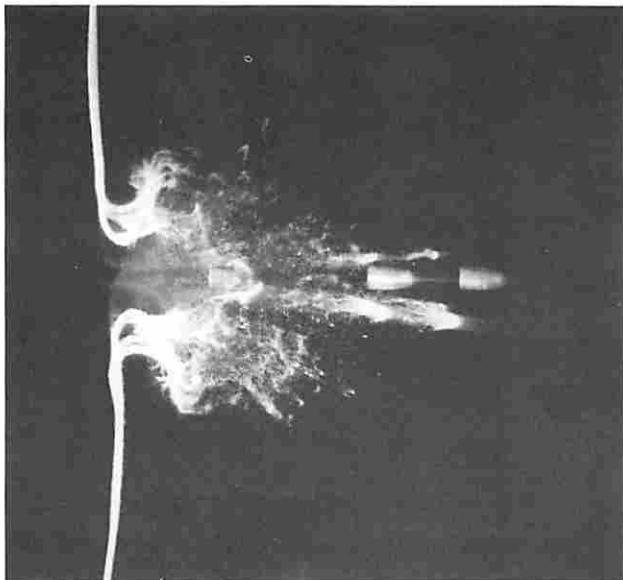

Figure 2-1. Unretouched photo of bullet breaking string shows how little even this fast-moving projectile travels during strobe flash. (Photo is multiple exposure, each image of the bullet corresponding to a different Strobotac flash, with a delay of approximately  $50\mu\text{sec}$  between each flash). See Figure 5-13.

## 2.4 TIMING IN HIGH-SPEED PHOTOGRAPHY.

The rapidity with which some events occur makes it not only impossible to "stop" the event with an ordinary flash bulb or camera shutter but also impossible to trip the shutter and flash the light at the proper moment. What is needed is a device that will automatically set off the flash just as the subject is in the desired position or as the action is in its proper phase for the picture. There are many ways of arranging such a device, several of which are discussed in Section 5. Essentially, automatic triggering requires (1) a sensor, which will interact with the subject and produce a signal — mechanical or electrical — that can be used to trigger the flash (and sometimes to trip the camera shutter), and (2) a means of adjusting the sensor or the signal it produces so that the arrival of the triggering impulse corresponds with the correct position of the subject. To photograph a bullet, a photographer can use a microphone as the sensor. The sound or shock waves caused by the firing of the bullet, acting on the microphone, produces an electrical impulse that fires the flash. The means of synchronizing the flash with the bullet's position can be either the variation of the position of the microphone or a variable electrical delay between the production of the impulse at the microphone and the arrival of the trigger signal at the stroboscope.

## 2.5 A SPECIFIC EXAMPLE

Assume a study of thread motion in a high-speed sewing machine is to be made. What type of stroboscope is best suited for the job? The machine speed is 5000 stitches per minute; hook speed is 10,000 rpm. A flash duration of 10 microseconds will be sufficient to stop the motion of the hook (assuming the hook has a relatively small diameter). Since the area to be photographed is small, the camera and light can be placed close to the subject. Hence, a relatively low intensity flash is sufficient. In order to stop the machine's action at any desired point, it is necessary to have a trigger signal synchronized with the motion of the machine and a time delay for varying the relative phase between trigger signal and motion.

Consulting Table 2-2, we see that the GR Type 1531, the GR Type 1538, and the GR Type 1539 meet the specifications for flash duration, repetition rate, and intensity, and that the 1531-P2 Flash Delay Unit along with the 1536 Photoelectric Pickup may be used with any one of these instruments to trigger the flash in the desired manner.

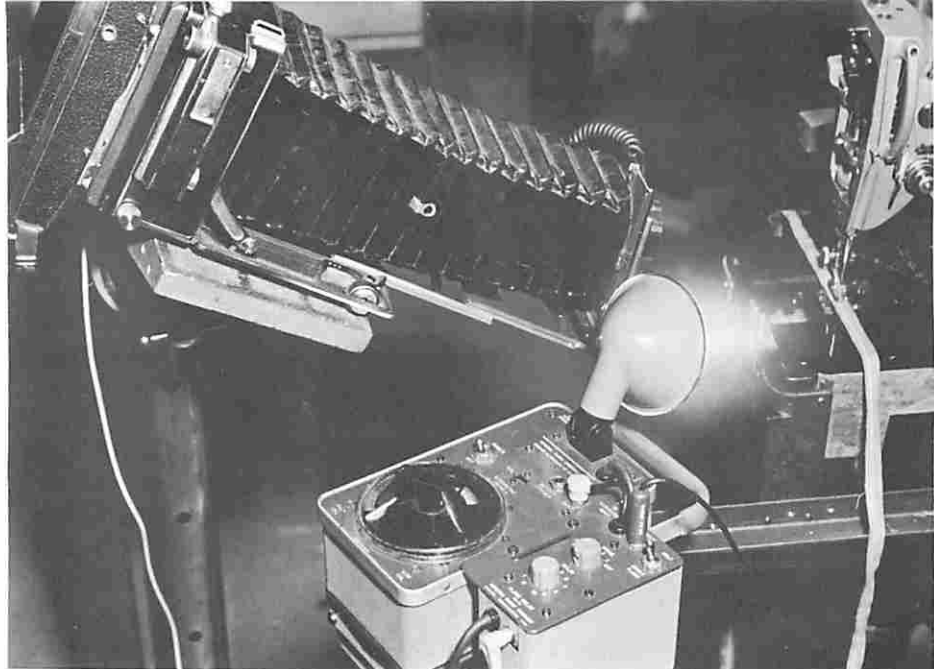
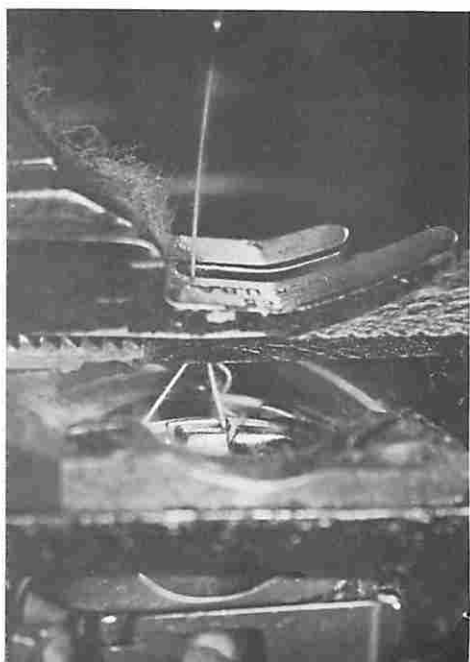
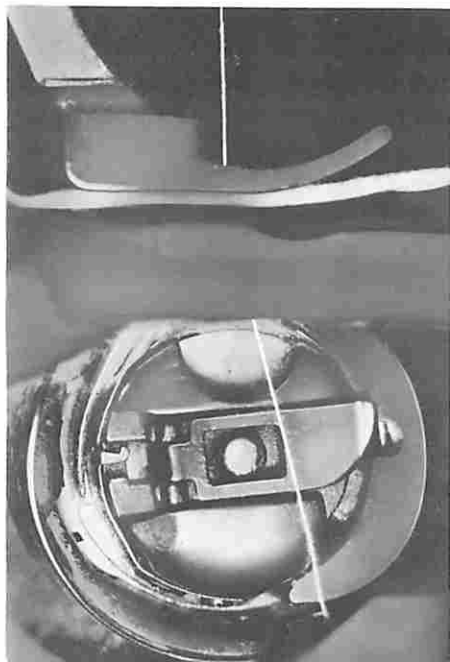

Figure 2-2.

Study of thread behavior in high-speed sewing machine. Machine speed is 5000 stitches per minute; hook speed is 10,000 rpm. Photograph above shows Linhoff with Polaroid film, Strobotac with attached Flash Delay, and sewing machine (base is cut away to expose parts). Photograph at lower left shows hook action on thread at a specific phase selected by the Flash Delay. Photograph at lower right is taken from a higher angle to show the stitch-forming action just under the sewing surface. *Courtesy of The Singer Company.*



The selection of one of these instruments depends on economic considerations and on what other uses, if any, the strobe is to be put. The 1539 Stroboslave, lacking an internal oscillator, would not be chosen if it is desirable to have the light flash at rates other than that of the sewing machine.

The use of a frequency close to that of the object being viewed is a technique commonly employed to produce the optical illusion of slow motion. If the flashing rate is slightly higher than the speed of the device being observed, the device will be illuminated at successively earlier points in its cycle and will thus appear to move slowly backwards. Similarly, a flashing rate slightly lower than the device speed will produce the effect of apparent forward slow motion. For such an application, the 1531 and the 1538, having internal oscillators, are recommended.

The Type 1538-A might be preferred if it is to be used for successive machine-to-machine inspections since it can be battery powered and is completely portable. For aid in choosing the right instrument, the following section describing the General Radio line of stroboscopes and related equipment has been included.

**TABLE 2-3**  
**TRIGGERING REQUIREMENTS**  
**FOR GENERAL RADIO STROBOSCOPES**

	Type 1531 STROBOTAC	Type 1538 STROBOTAC	Type 1539 STROBOSLAVE	Type 1540 STROBOLUME		
				with 1540-P1	with 1540-P3	with 1540-P4
Make-Break Contacts	Fires on con- tact opening	Fires on con- tact closing	Fires on con- tact closing	Fire on con- tact closing	Fire on con- tact closing	Selectable; will fire on either closing or opening
Photoelectric Pickoff	1536 + 1531-P2	1536 + 1531-P2 or 1537	1536 + 1531-P2 or 1537	1537	1537	1536 or 1537
Electrical Signal	Pos pulse: 6 V  Sine wave: 2 V rms @ 5 c/s or higher	Pos pulse: 1 V  Sine wave: 0.35 V rms @ 100 c/s or higher; 3.5 V rms @ 5 c/s	Pos pulse: 2 V	Pos pulse: 1 V	Pos pulse: 1 V	Pos pulse: 1 V Sine Wave: 0.35 V rms from 100 to 400 c/s, increasing to 3.5 V rms @ 5 c/s

## **section 3**

# **GENERAL RADIO STROBOSCOPES**

### **3.1 THE TYPE 1539 STROBOSLAVE<sup>®</sup> ELECTRONIC STROBOSCOPE.**

**3.1.1 GENERAL DESCRIPTION.** The Type 1539 Stroboslave (Figure 3-1) is a miniature electronic stroboscope. The Stroboslave satisfies the basic requirements for motion studies and high-speed photography, but is not suitable for tachometry as it has no internal oscillator. Its reflector-lamp assembly is connected to the case by a five-foot extension cable so that the lamp can be used either attached to the case or conveniently positioned over the subject, even in cramped spaces. The reflector can be removed so that the strobotron lamp assembly can be inserted through a hole as small as one inch in diameter to observe objects in otherwise inaccessible areas (see Figure 3-2). When the reflector is in place, the light output is concentrated into a long-throw 10-degree beam (measured at one-half-peak-intensity points) with an apparent source 18 inches behind the reflector front. For further, more specific information on the photographic characteristics of the 1539 as a light source with and without reflector, refer to Section 4. The Stroboslave has the same high maximum flash repetition rate, short flash duration, and the same light characteristics as the 1531 and 1538 Stroboscopes.

**3.1.2 TRIGGERING THE STROBOSLAVE.** The Stroboslave can be triggered by the closure of a switch across its input terminals or by a positive voltage pulse of at least 2 volts peak amplitude. The Stroboslave can therefore be triggered by the output pulse of the 1538 Stroboscopes, the 1531 Stroboscopes through a 1531-P4 Trigger Cable, the 1531-P2 Flash Delay, or by the 1537 Photoelectric Pickup. (A table showing all possible interconnections of the various General Radio Stroboscopic instruments is given in Section 5.) This multiplicity of trigger possibilities, along with its small size and low cost, make the Stroboslave a most convenient and economical instrument for a variety of applications.



Figure 3-1. The 1539-A Stroboslave.

**3.1.3 USES OF THE STROBOSLAVE.** In some applications it is desirable to light the subject from more than one side in order to obtain greater depth and detail in the photograph. One or two Stroboslaves can be used in this case to produce modeling illumination in arrangements similar to those used in multiple photo-flood lighting. The Stroboslaves are triggered by one Strobotac if a particular flash repetition rate is needed; otherwise they can be triggered by the same external signal synchronized to the subject.

In photographing high-speed machinery where the subject is moving in some constant cyclical manner, the combination of the Stroboslave and the 1537 Photoelectric Pickoff is the most convenient and economical light source available, (refer to paragraph 5.2.3 for a description of the 1537).



Figure 3-2. Using the Stroboslave to illuminate the interior of a metal stencil imprinter.

## 3.2 THE TYPE 1531 STROBOTAC<sup>®</sup> ELECTRONIC STROBOSCOPE.

3.2.1 GENERAL DESCRIPTION. The Type 1531 Strobotac electronic stroboscope (Figure 3-3) is a versatile, inexpensive, high-speed light source designed to fill a wide variety of both photographic and non-photographic needs in science and industry. Its light weight and compact design make it convenient to use, and its light output is suitable for taking many different types of photographs. (Refer to Section 4). A self-contained electronic oscillator enables the unit to operate independently at flash rates from 110 to 25,000 flashes per minute. The flash rate is continuously adjustable throughout this range, and it can be accurately set ( $\pm 1\%$ ) by means of the large calibrated dial on the instrument panel.

The Strobotac is housed in a carrying case whose cover doubles as an adjustable stand (see Figure 3-3), and protects the instrument from damage while in transit. The unit can be easily carried to any location. Power requirements are flexible. Either 120- or 240-volt ac, 50- to 60- or 400-cycle power is satisfactory; maximum input power is 35 watts.



Figure 3-3.

The 1531 STROBOTAC<sup>®</sup> electronic stroboscope – versatile light source for both high-speed photography and visual stroboscopy.

Photographers particularly appreciate the ease with which the lamp reflector can be positioned. The long-throw light beam can be rotated through  $360^{\circ}$  horizontally and  $180^{\circ}$  vertically without movement of the instrument case, and the reflector can be quickly and easily removed from the flash-lamp mount when it is desired to illuminate hard-to-reach areas. When the reflector is in place, the light output is concentrated into a long-throw  $10^{\circ}$  beam (measured at one-half-peak-intensity points) with an apparent source 18 inches behind the reflector front. For further, more specific, information on the photographic characteristics of the 1531-A as a light source both with and without reflector, refer to Section 4.



**3.2.2 EXTERNAL TRIGGERING.** The Strobotac can be triggered by a wide variety of externally produced signals. An electrical signal of at least 6 volts peak-to-peak amplitude can be used, but a simple contact "make" or "break" is satisfactory. With the Strobotac range switch set on EXT INPUT, LOW INTENSITY, the repetition rate of the instrument can be extended by the use of an external pulse source, beyond its internal, calibrated range to 600 to 800 flashes per second, and rates as high as 1000 per second are sometimes possible, depending on the condition of the Strobotron flash lamp.

With the RPM dial rotated fully clockwise, the Strobotac triggers with either a positive-going electrical signal or by the opening of a set of contacts connected to the INPUT jack. In either case, the light flash follows the trigger signal with only a few microseconds delay. In practically all instances this small delay introduces no difficulties, and the light flash can be considered instantaneous.

If only a negative pulse or contact closure is available for triggering, slight modifications must be made in the triggering connection. For triggering on the leading edge of a negative electrical pulse, a General Radio Transformer Cable, Type 1532-P2B, should be used to reverse its polarity. The oversize plug on one end of this cable is plugged into the Strobotac INPUT jack, and the normal phone plug on the other end is connected to the pulse source. The RPM dial is then set fully clockwise as for positive-pulse triggering. Practically any pulse transformer may also be used instead of the 1531-P2B Cable to perform the same function.

A contact closure can be made to trigger the Strobotac with minimum delay by the simple inverting circuit diagrammed in Figure 5-10. The necessary parts can be purchased at any radio or electronics parts supply house for less than \$2.00, and only a few minutes are required to assemble them. Contacts in camera shutters equipped for "X" synchronization normally operate satisfactorily with this circuit, but some difficulty may be experienced if the contacts "bounce" when closing. (The Strobotron will fire *each* time electrical contact is made.) A small capacitor (approximately 0.01 microfarad) connected across the contact terminals usually solves this problem.

The 1531-P2 Flash Delay contains special circuitry to provide the same pulse-inverting function described above, so with this unit minimum triggering can also be accomplished directly from a contact closure.

### 3.3 THE TYPE 1538 STROBOTAC<sup>®</sup> ELECTRONIC STROBOSCOPE.

3.3.1 GENERAL DESCRIPTION. The 1538 (Figure 3-4) is an electronic stroboscope that combines several new, formerly unobtainable, features in a lightweight, moderately priced instrument. Although the appearance and general design are similar to those used in the 1531 Strobotac, the 1538 is capable of a flashing rate six times as high – up to 150,000 flashes per minute, and its frequency stability is much better than that of the 1531. The 1538 stroboscope has the additional features of either ac or dc operation (supplied by an accessory battery pack), an accessory remote lamp unit to illuminate in close quarters, and an accessory large capacitor to produce high-intensity flashes for single-flash photography. When the reflector of the 1538 is in place, the light output is concentrated into a long-throw 10-degree beam (measured at one-half-peak-intensity points) with an apparent source 18 inches behind the reflector front. In addition, the 1538 employs solid-state circuits for zero warm-up time, so that the instrument may conveniently be turned off when not actually in use.



Figure 3-4. Type 1538-A Strobotac electronic stroboscope shown with accessories: 1538-P2 Extension Lamp; 1538-P3 Battery and Charger for portable operation; and the 1538-P4 Energy Storage Capacitor (shown mounted on the base of the 1538-A).

The flashing rate of the 1538 Strobotac is controlled by an internal generator and is adjustable from 110 to 150,000 flashes per minute. This overall range is divided into four direct-reading ranges on the large, illuminated range-control knob. The first three ranges are the same as those of the 1531, and the fourth covers from 24,000 to 150,000 flashes per minute, calibrated. A fifth position on the range switch provides for calibration. To avoid reading errors, only the range in use is illuminated. A larger-diameter flashing-rate control, concentric with the range knob, provides precise setting of the flashing rate. With the exception of the higher flashing rates and the 44-million-beam-candle, 8-microsecond single-flash available when using its accessory 1538-P4 Capacitor, the light characteristics of the 1538 Strobotac are the same as those of the 1531. For further, more specific information on the photographic characteristics of the 1538 as a light source with and without reflector, refer to Section 4.

**3.3.2 EXTERNAL TRIGGERING.** The flash can be triggered externally by a simple contact closure across the input terminals, by a positive pulse (1-volt peak), or by a sine wave (0.35 volt rms). With a photoelectric pickoff (refer to Section 5), the flash can be triggered by pulses that are synchronized with a mechanical motion. With the combination of the 1531-P2 Flash Delay and the 1536 Photoelectric Pick-off, an adjustable delay is introduced between the time a selected point on a moving object passes the pickoff and the time at which the Strobotac flashes. Three-way synchronization of the camera shutter, the mechanical motion, and the Strobotac firing is a very useful feature of this Pickoff-Flash Delay combination. The Strobotac has an output signal of +7 volts, which is sufficient to trigger other stroboscopes or slave units.

**3.3.3 APPLICATIONS OF THE TYPE 1538-A STROBOTAC.** With the shorter flash duration and higher repetition rates attainable with the 1538 Strobotac, it is possible to make photographs and motion studies of much faster moving subjects than with the 1531. In addition, battery operation of the 1538 makes possible high-speed photographic studies of equipment in locations where no electrical power is available.

The 1538 Strobotac has the same type of removable lamp assembly as the Stroboslave, which means that the 1538 can also be used in cramped spaces.

### 3.4 THE TYPE 1540 STROBOLUME ELECTRONIC STROBOSCOPE.

The 1540 might well be considered a stroboscopic "floodlight." Its high-intensity flash combines with a wide beam angle to effectively illuminate both large-sized subjects and subjects that are in areas having high ambient-light levels. Three control units are available to permit either slaved, speed-measuring, x-synced single-flash-photographic or delayed-flash motion-analysis operations. These control units are described in paragraph 3.4.1.

The flash from the Strobolume provides about 20 times more light output for any corresponding flash-rate setting than the Strobotac. The 1540 Strobolume is ideal for high-speed photography; for example, the unit, at its highest flash intensity, has a guide number of 70 for High-Speed Ektachrome (ASA 160). Auxiliary booster capacitors can be added for even higher single-flash intensities. The beam angle can be adjusted from a wide 7 x 13-foot pattern to a narrow 3 x 13-foot pattern (at a 10-foot distance, see Table 4-1). The flashing rate of the 1540 can be adjusted continuously from a low of 30 to a high of 25,000 flashes per minute. Flash duration is 15  $\mu$ s, 12  $\mu$ s, and 10  $\mu$ s on the high-, medium-, and low-intensity positions.

The packaging of the 1540 Strobolume is unique in that the power supply, control unit, and lamphead separate and cable connect for applications requiring a remote light source. For one-hand operation, the lamphead and control unit attach into a single integral unit. Or, the lamphead can be conveniently mounted on a tripod, with or without its control unit.

#### 3.4.1 STROBOLUME CONTROL UNITS (Types 1540-P1, -P3, -P4).

Type 1540-P1 Strobolume Oscillator. This unit, Figure 3-5 (A), makes the 1540 essentially a high-power Strobotac. Designed for speed measurements, the 1540-P1 features a calibrated flashing-rate control for  $\pm 1\%$  measurements from 110 to 25,000 rpm. Speeds up to 250,000 rpm can be measured by harmonic techniques. It can also be externally triggered (see Table 2-3), has a trigger output, and a pushbutton for unsynchronized single-flash photography.

Type 1540-P3 Strobolume Control Unit. Actually with this unit, Figure 3-5 (B), the control of the Strobolume comes from an external triggering source such as another stroboscope, 1537 Photoelectric Pickoff, or a contacting mechanism. This unit makes the 1540 an ideal slave light source for the Strobotac (when used with a 1531 Strobotac a 1531-P4 Adaptor cable is required). Input requirements are listed in Table 2-3.

Type 1540-P4 Oscillator/Delay Unit. The ideal control for motion analysis and high-speed photography, this unit, Figure 3-5 (C), has a delay circuit much like the 1531-P2 (see paragraph 5.3.1). An amount of time delay adjustable from 100  $\mu$ s to 1 s can be inserted into the triggering circuit to delay the time at which an external input signal will flash the 1540. This permits phasing of the flash with the motion of the subject to allow both visual and photographic analysis in a point-by-point manner. An input is provided for cameras having X-sync, for both delayed and nondelayed synchronized single-flash photography. The 1540-P4 will accept a variety of input trigger signals (see Table 2-3). One unique feature not found in other GR stroboscopes bears mentioning. When the 1540-P1 is used with photoelectric pick-offs, it can be made to trigger from either a reflective or nonreflective mark. This is described in paragraph 5.2.3. In addition, the 1540-P4 has an adjustable uncalibrated oscillator for varying flash rate from 30 to 25,000 flashes per minute. A pushbutton is also provided for burst-flashing the 1540 for multiple-exposure photography.

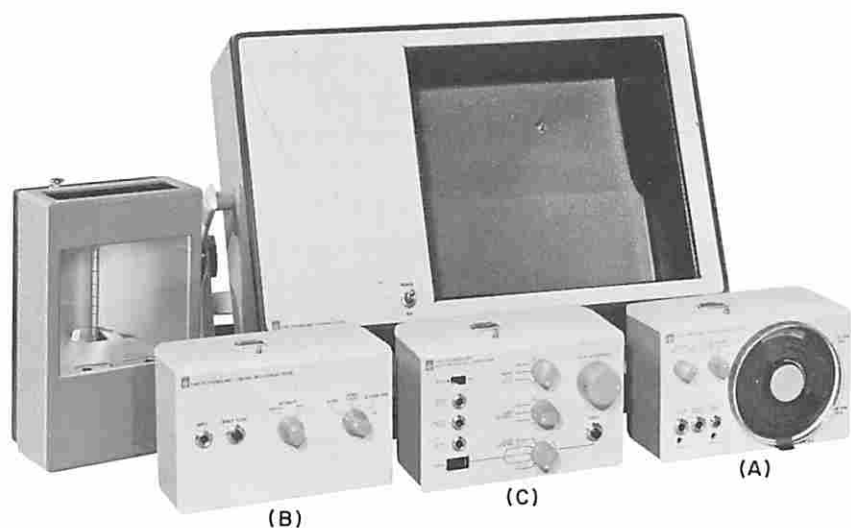

Figure 3-5. The Type 1540 Strobolume and Control Units.

## section 4

# STILL PHOTOGRAPHY

### 4.1 GENERAL.

The taking of a high-speed photograph, which we will define in this book as the photographing of an event which occurs at a rate (linear velocity, angular velocity, growth rate, etc.) faster than one hundred feet per second is made difficult by the inherent slowness of two things: the camera and the photographer. The slowness of the camera obliges the photographer to seek a fast substitute for the shutter, and the slowness of the photographer necessitates the use of some sort of automatic timing device for the coordination of subject and camera. Such devices will be discussed in detail in Section 5. The special problems encountered with the camera-light-film system in high-speed photography are discussed below.

### 4.2 THE OUTPUT CHARACTERISTICS OF GENERAL RADIO STROBOSCOPES.

A xenon lamp is usually employed in stroboscopes because of its high efficiency in converting electrical energy into light. The flash is defined by the light-vs-time curve in Figure 4-1, and the spectral distribution plot in Figure 4-2. The flash duration used in the specifications is defined as the time during which the light intensity is greater than one-third of the peak value. Most of the light is emitted during this period, and little of the total light is contained in the lingering "afterglow" or "tail".

The light produced by the lamp is concentrated by a reflector. The apparent source of the light beam thrown by the General Radio Types 1531, 1538, and 1539 Stroboscopes is 18 inches behind the reflector front. The beam-angle of this source is  $10^\circ$ , so that a narrow cone of light is produced by the flash. Outside this  $10^\circ$  cone the light intensity falls off sharply, so that the area of reasonably constant illumination is not large. Since a variation of 2:1 in incident light intensity corresponds to an exposure increment of approximately one f-stop setting, the diameter of the  $10^\circ$  beam cone provides a good approximation to the useful illumination area of the Strobotac when the

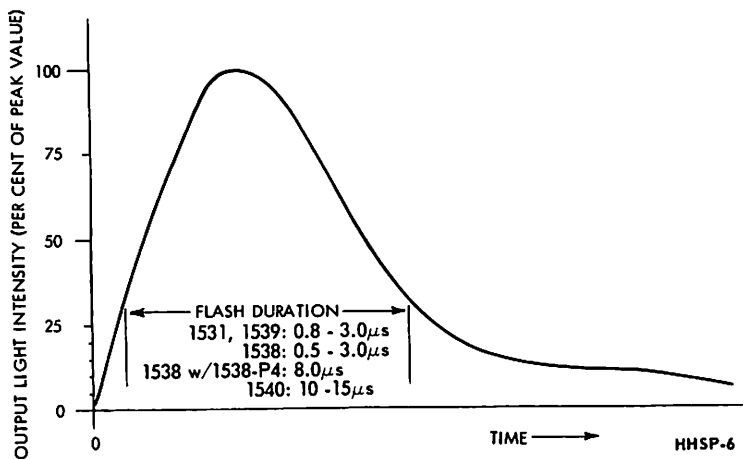

Figure 4-1a. Output light intensity vs time for GENERAL RADIO stroboscopes.

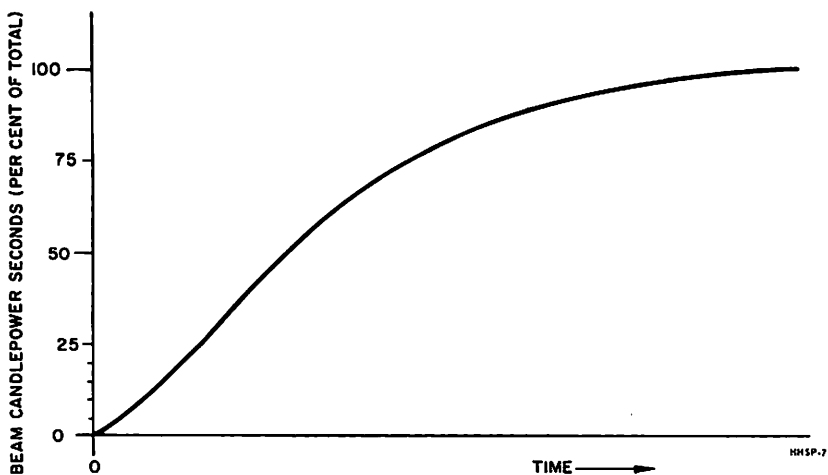
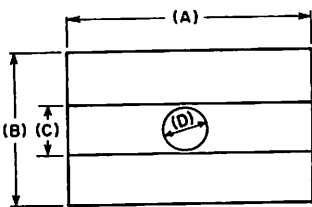
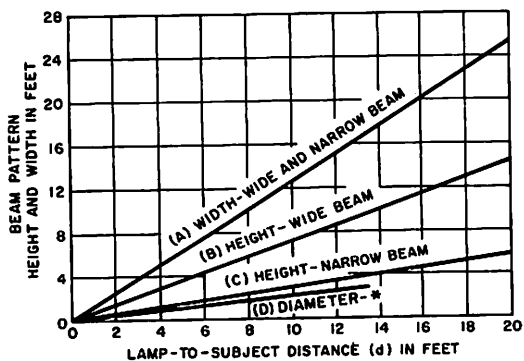
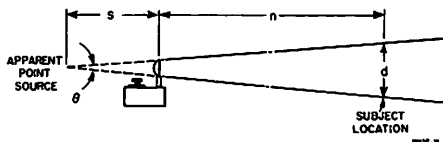

Figure 4-1b. Integrated light of the pulse of Figure 4-1a as a function of time. Note that most of the total light to which the film responds is produced during the interval that defines flash duration.

reflector is attached. These spot diameters are tabulated for several lamp-subject distances in Table 4-1. If this beam diameter is too small to light the subject adequately, remove the reflector and a larger surface area can be illuminated by the bare flash lamp. The light density falling on a given subject area decreases when this is done, but with care, useful exposures can often be obtained of an area six to eight feet wide. Light density can be increased by adding a "do-it-yourself" reflector constructed from either foil or mirrors.

Table 4-1.  
Illuminated Spot Diameters

Lamp-to-Subject Distance (n) Feet	Diameter "d" of Illuminated Spot at Half-Peak-Intensity Points
	Type 1531, Type 1538 Type 1539 (S = 1.5 ft, $\theta = 10^\circ$ ) Inches
1	5
2	7
3	9
4	12
5	14
6	16
7	18
8	20
9	22
10	24



EQUIVALENT SIZES OF BEAM PATTERNS

\* CIRCULAR BEAM OF STROBOTAC AT 1/2 INTENSITY POINTS

1540-20

Comparison of beam patterns between the Strobolume (A, B, and C), and the Strobotac (D).



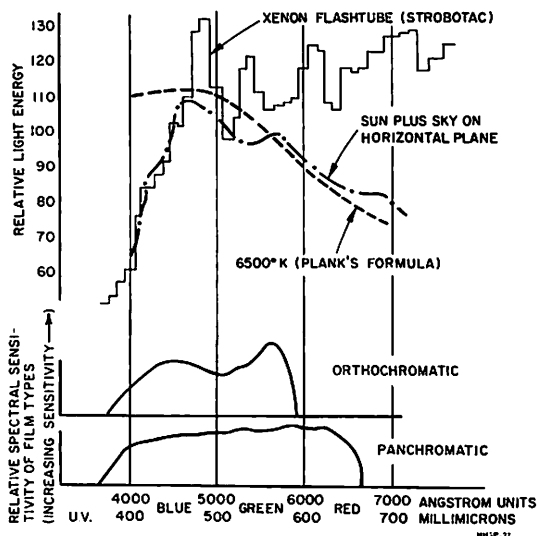

Figure 4-2. Comparison of xenon lamp spectral emission and film sensitivity. Note that xenon radiation in the U.V. range is absorbed by and does not pass through the glass well.

### 4.3 FILM CHOICE.

A xenon-filled flashtube, such as that used in most stroboscopes, produces good results on both orthochromatic and panchromatic films because most of the light emitted falls in the visual region where both types of film are sensitive (see Figure 4-2 for a graphical comparison of film sensitivities to the spectral content of a xenon flashtube emission). Orthochromatic films, however, will not take full advantage of this type of output, and panchromatic types are preferable for applications where the flash intensity is marginal.

The equivalent color temperature of the flash produced by GR strobes is approximately 6500° - 7000° Kelvin. While the bare flash may produce acceptable results with color films under some conditions, use of the filters may result in improved color balance. Not shown in Figure 4-2 are the strong lines present, including some in the vicinity of 9800 angstroms, the near infra-red region.

To maximize depth of field by using the smallest possible aperture for a given amount of light, it is common practice to employ the fastest possible films for high-speed photography -- black-and-white and color. The effective film speed may be augmented by "pushing" the film, i.e., by overdevelopment, post-exposure techniques, etc. The penalty for such practices is usually reduced picture quality. Each film has different exposure characteristics and will yield different results depending upon which technique is used. Speed alone is often a poor criterion for choosing film. It is advisable that the film manufacturer's data be examined to determine the most desirable combination of materials and processing. A few trial exposures also should be made to be sure that graininess, contrast, enlargeability, etc. are all acceptable.

A convenient way to make trial exposures is to take experimental pictures using Polaroid film having the same ASA number as the film intended for the final pictures. This film can be used, however, only in cameras designed to process it or in adapters which convert (generally 4 x 5) cameras to the system. Most Polaroid cameras except the Swinger, the Model 80 series, the Model J33, Model J66, and the original Model J95 are equipped with "X" contacts. Polaroid will modify the Model J95 for X-contact synchronization at additional cost. All models have "time" and "bulb" positions so that strobe pictures may be taken under low ambient light conditions as described in paragraph 4.7. Automatic exposure models of Polaroid cameras can be used to take strobe pictures if used in a non-automatic mode as described in Bulletin #C245B and Bulletin #C249A available from the Polaroid Corporation.<sup>1</sup>

Occasionally, in the photographing of subjects moving at extremely high speed, the exposure due to the lingering flash "tail" (see Figure 1-2) will cause a slight blur ahead of a moving object's image in the direction of its travel. This undesirable effect can be reduced with black-and-white film by the reduction of the lens aperture and a corresponding increase in the negative development time. Exposure during the higher intensity period of the light flash is thus emphasized, and the effective flash duration is reduced, i.e., contrast is improved by underexposing and overdeveloping. High-speed films usually work best for this purpose because of their greater sensitivity to the lower total exposure. Also, whenever possible, the subject's highlights can be dulled with commercial dulling spray or a mixture of BonAmi and water.

---

<sup>1</sup> Polaroid Corporation, Customer Services, 119 Windsor Street, Cambridge, Mass. 02139

#### 4.4 GUIDE NUMBER CHART.

A guide number expresses the relationship between the lamp-to-subject distance and the lens aperture :

$$\text{Effective lens aperture (f/number)} = \frac{\text{Guide Number}}{S + \text{lamp-to-subject dist. in ft.}}$$

where S is the distance of the apparent source behind the reflector. Just as its name implies, the guide number is a help in establishing the correct aperture. It is just a guide and never should be accepted as gospel...particularly in high-speed photography where film is prone

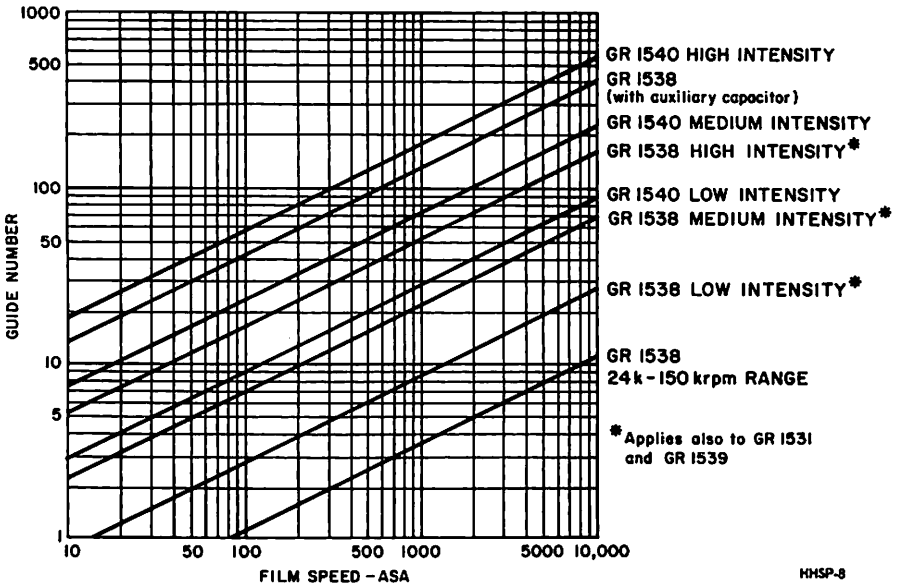

Figure 4-3. Guide number vs film speed for various GR stroboscopes and settings.\* The outputs of the Types 1531 and 1539 are the same as the outputs for corresponding 1538 settings. Note that "high intensity" occurs on low-speed range (i.e., low-flashing rate). Data are for single-flash operation. Film should be processed in accordance with manufacturer's recommendations.

Effective lens aperture (f/number) = guide number / (1.5 + distance from lamp to subject in feet). When camera is placed close to the subject, this computed f/number setting should be multiplied by the K factor found from Figure 4-5 to find the recommended lens setting.

to reciprocity failure. Factors such as the reflectivity and contrast characteristics of the subject being photographed must also be considered. The guide numbers for General Radio stroboscopes may be obtained from Figure 4-3. This chart is based on the single-flash light output of the various GR strobes and is valid for films at published speed processed according to the manufacturer's recommendations. Use of the Guide Number Chart is best illustrated by an example. Assume that the high-intensity range of a Type 1531 is to be used to expose film with a speed of ASA400. A vertical line is drawn at 400 to intersect with the appropriate intensity line. A horizontal line is drawn from the intersection to the left-hand scale from which guide number, in this case 33, is read directly. A further example will be found in Section 5, which illustrates other factors involved in selection of intensity range, etc.

The effective aperture derived from the guide number may require one or more corrections to obtain the indicated aperture (actual aperture setting of lens). If the strobe flashes repetitively, the light output-per-flash may be below the single-flash value. The curves of Figure 4-4 show the required correction as a function of flash rate.

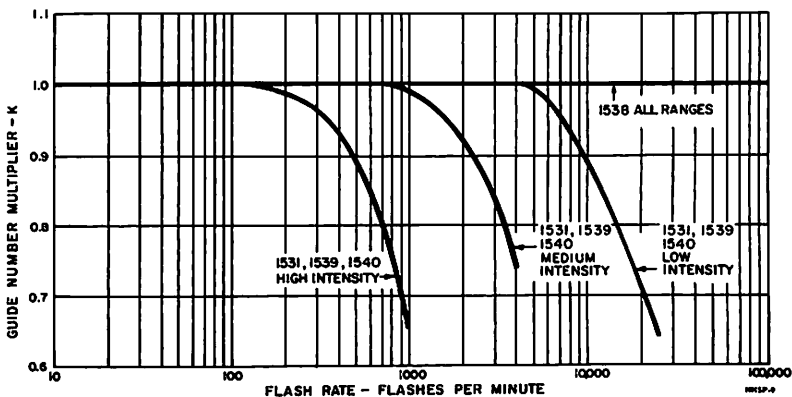
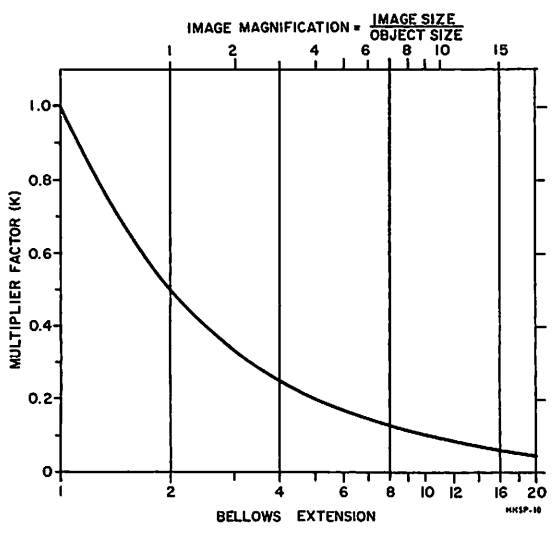

Figure 4-4. Guide-number correction for repetitive flashing.

At extremely short camera-subject distances, the camera lens must be moved away from the film plane in order to bring the subject into focus. This decreases the amount of light reaching the film, and the lens aperture setting must be adjusted to compensate for this loss. The curve in Figure 4-5 provides a straightforward means for determining the amount of adjustment required for either a given bellows extension or a given image magnification.



Indicated aperture =  $K \times$  effective aperture

Bellows extension =  $25.4 \times \frac{\text{Lens-to-film plane distance in inches}}{\text{Focal length of camera lens in millimeters}}$

Figure 4-5. When camera is located close to the subject, multiplier factor for determining indicated aperture (correct lens f/number setting) from effective aperture (calculated from guide number data).

#### 4.5 LIGHTING TECHNIQUES.

Many times objects to be photographed at high speed do not contrast well with their backgrounds, and it is difficult to achieve clear, high-definition pictures of them. This difficulty is augmented by the usual absence of auxiliary light sources. Often this situation can be greatly improved simply by either a light or a dark background behind the subject. If several objects or moving parts are being studied simultaneously, different colors or shades of paint can be used to improve

contrast between them. Another way to improve the definition of a high-speed photograph is to use a "slave" stroboscope as a second light source for more modelled illumination. An instrument recommended for this purpose is the General Radio Type 1539-A Stroboslave with either the Type 1531-A Strobotac electronic stroboscope or the Type 1538-A Strobotac electronic stroboscope. Other combinations of General Radio instruments for this purpose are possible. (Refer to Table 5-2.)

Light colored backgrounds, such as white paper or cardboard, tend to produce troublesome reflections when the light source and camera are directed at the subject from certain angles. Relocation of the stroboscope may help in these situations, or it may be desirable to switch to a dark, nonreflective backdrop (black velvet is about the best, but any dull black surface may be used). The use of black background or side lighting is almost a necessity for taking multiframe pictures to prevent image "wash-out" by succeeding flashes. If bright "hot spots" are evident, the stroboscope should be moved away from the subject or the light beam should be bounced onto the subject from a light-colored, diffusing reflector (white matte paper is a good material for this purpose).

Side reflectors can be used to advantage when one side of the subject is brightly illuminated and another side is darker. A mirror or household aluminum foil is a good material for this purpose. The foil will diffuse light effectively if it is loosely crumpled, then gently opened out and formed into a rough reflector.

Scotchlite is another reflecting material which has many uses in high-speed photography. It is manufactured and sold by The Minnesota Mining and Manufacturing (3M) Company and has the peculiar characteristic of reflecting light striking its surface back in the direction from which it came, with an efficiency almost 200 times that of an ordinary white surface. Scotchlite is available in widths up to 36 inches, packaged in rolls from 5 to 72 yards long. It has a pressure-sensitive adhesive backing for easy application to flat surfaces. The silver (#3270) and imperial white (#3280) colors are most highly reflective, and consequently most useful photographic purposes.

Because of its extremely high reflective efficiency, Scotchlite is an ideal material for marking critical portions of a moving object being studied at high speed. A small Scotchlite marker will contrast well with its background even under high ambient light conditions, and

the relative position of these markers can often be discerned in a photograph that would otherwise be useless.

When it is necessary to remove the stroboscope reflector in order to illuminate hard-to-reach spots, the drop in light concentration often is a problem. Ordinary household aluminum foil, when carefully smoothed on a flat surface and attached to one side of the flash lamp with clear cement, serves as a miniature reflector to minimize this reduction. Be sure the flash lamp is clean and the brightest side of the foil is placed toward the inside of the lamp. Best results are usually obtained when the foil covers about half of the lamp between the two spark electrodes, as shown in Figure 4-6:

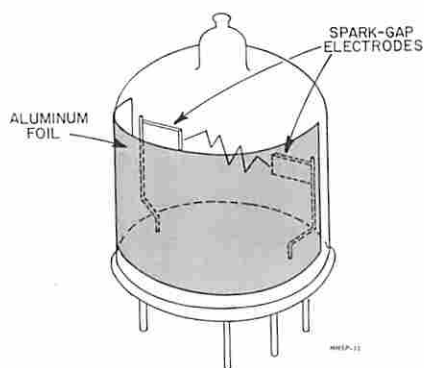

Figure 4-6.  
Application of an auxiliary reflector to the Strobotron.

#### 4.6 SHADOWGRAPH PHOTOGRAPHY WITH A SCOTCHLITE SCREEN.

Shadowgraph photography is a technique used to study intense shock waves and fluid disturbances. Dr. Harold Edgerton has described a technique for taking such photographs using a Scotchlite screen as a reflective backdrop. For good definition with this method, an intense point light source must be located as close to the camera lens as possible. The Strobotac is ideally suited for this application since the Strobotron spark discharge gap closely approximates a point light source when directed as shown in Figure 4-7. Because of this, the light output can be concentrated optically into a high-intensity beam for special applications.

The bare Strobotron lamp is positioned next to and slightly behind the camera lens as shown in Figure 4-8, so that light is reflected from the screen back through the subject plane and onto the film.

Focus the camera lens sharply on the Scotchlite screen, NOT on the subject itself, and be sure there is at least six inches between the screen and the subject. Sharp density gradients in the fluid surrounding the subject will then show up as dark lines against the brightly lit screen. The further the screen is separated from the subject, the darker the shock pattern will appear in the photograph, and, the less sharp the subject outline will appear for a given depth of field.

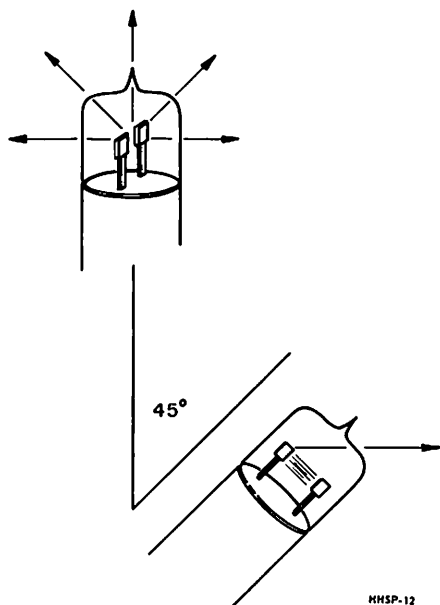

Figure 4-7. The arc of the Strobotron tube used in the 1531, 1538, and 1539 closely approximates a point source of light. The arc is cylindrical in shape, only 5/16 of an inch long and 1/16 of an inch in diameter.

#### 4.7 AMBIENT LIGHT CONDITIONS.

When high-speed flash photographs are taken in a darkened room, the camera shutter may be left open for a considerable period of time without fogging the film. A trick used by many photographers when they must shoot under these conditions is to use orthochromatic (red insensitive) film and work under red illumination. If the shutter is equipped with a "Time" or "Bulb" setting, it may be opened manually, held open until the light flash can be conveniently triggered (usually



Figure 4-8. Shock-wave photography with a Scotchlite screen.

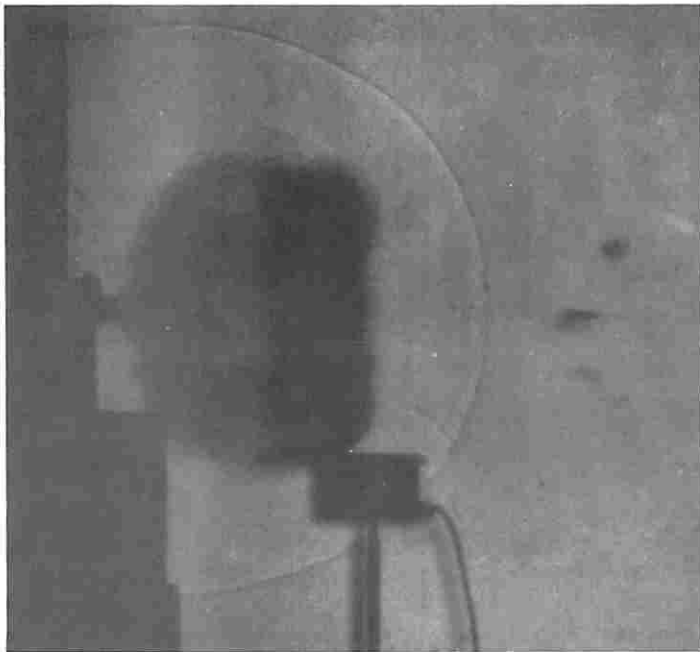

(Photograph courtesy of Dr. Harold E. Edgerton, M.I.T.)

This shadow photograph of a .30-calibre bullet being fired from a Springfield rifle clearly outlines the spherical sound wave emanating from the gun's muzzle. In the original photograph, the conical shock layer of compressed air extending back from the bullet's nose can be seen; similar shock waves produce ear-splitting sonic booms when jet planes break the sound barrier.

A 4-foot reflective screen of Signal Silver Scotchlite was located 10 feet from the camera. The rifle was 5 feet from the camera. A 135-mm lens was used at  $f/4.7$  with Polaroid Type 52 positive film (ASA 200). A microphone triggered the high-intensity Strobotac flash.

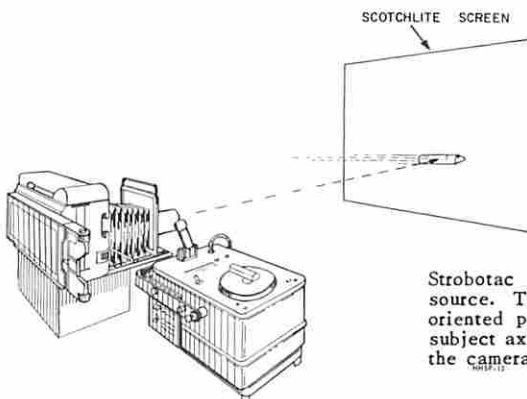

Strobotac used as a point light source. The spark gap must be oriented parallel to the camera-subject axis and as close beside the camera lens as possible.

by the object being photographed, as outlined in the synchronization section), and then manually closed. Unfortunately, since very high-speed flashes are relatively low-intensity flashes that require large shutter-openings and fast film, almost total darkness will be mandatory while the shutter is open. This condition is always inconvenient, and sometimes impossible to maintain. The photograph may have to be taken out of doors or on location, or light may be needed to set the subject up for the picture after the shutter has been opened. In such cases shutter speeds must be fast enough to keep film exposure from ambient light down to an acceptable level. More specifically, film exposure caused by the strobe flash (determined by flash duration and intensity and by camera aperture setting) must be at least eight times, that is, 3 f-stops, greater than film exposure caused by ambient light (determined by ambient light intensity, camera shutter speed, and aperture setting). This can be done without much difficulty if the photograph is to be made of a repetitive event. The shutter may stay open for one or even several cycles of the event, yet the open time will remain very short, probably only a few hundredths of a second — and the picture may be taken in a well lighted room if necessary. The strobe flash may be synchronized through the X contacts of the camera, or it may be synchronized with the repetitive event. The details of this synchronization process are in the following section.

In multiple-flash photography of a nonrepetitive event, such as a golf swing, in which the exact time of the start of the strobe flashes is not critical, the camera shutter can be tripped manually and the flash burst triggered from the X contacts of the camera (refer to paragraph 5.3.3 for details).

When taken under light conditions such that the film would be fogged if the shutter were open more than a few thousandths of a second, a single-flash photograph or a multiple-flash photograph may be conveniently taken in high ambient light with the use of a device that will automatically trip the camera shutter on reception of a signal. Such a device is an electrically operated shutter-release solenoid, which is an accessory on some press cameras. There are also several units sold for adapting older cameras for flash photography. A competent camera repairman should install the device selected. These devices are very slow compared to many high speed events, but may prove useful for remotely opening the camera shutter to photograph the swing of a golf club and the like, where exact timing of the shutter opening is not crucial.

## 4.8 OPERATION OF CAMERA SHUTTERS AT HIGH SPEEDS.

At ordinary shutter-speeds, up to around one hundredth of a second, the time required to open the shutter is insignificant compared with the time the shutter remains open (see Figure 4-9). At higher speeds, however, the time it takes the shutter to open and close becomes a larger and larger portion of the rated exposure time as the size of the aperture is increased. For this reason it is advisable to check the shutter synchronization to make sure the flash occurs when the shutter is fully open. To do this, open the lens diaphragm to its widest aperture, remove the back of the camera to expose the rear of the lens, aim the camera at the Strobotac reflector, and trip the shutter.

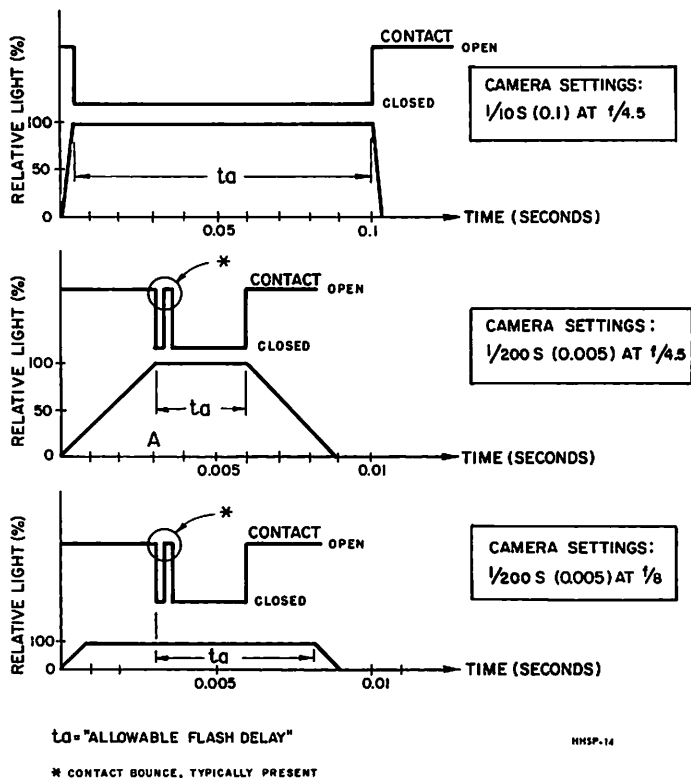

Figure 4-9. Light transmission and contact closure as a function of time for several settings of a typical between-the-lens, "X" synchronized shutter.

When the Strobotac flashes, a bright, clear circle of light should be visible through the camera lens. If the light circle appears no brighter than when the Strobotac is disconnected, the flash is not properly synchronized. A small light circle, or a circle with a jagged edge, indicates that the light flash is occurring during either the opening or closing of the shutter blades (see Figure 4-10).

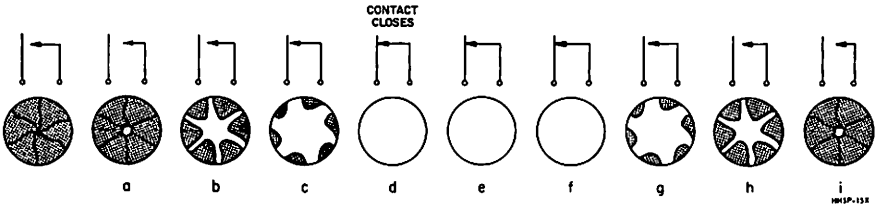

Figure 4-10. Between-the-lens shutter, showing proper instant of contact closure for X-synchronization.

The above test has the advantage that the shutter is tested at the speed which will actually be used. It will not indicate, however, whether contact closure occurs late in the shutter cycle (e.g. in Figure 4-10 at point g). Late closure would be an inconvenience if it were necessary to flash the strobe a short time *after* the contact closed. If such a delay is to be used, a second test can be performed to tell exactly where in the shutter cycle the contact will close. The test, which is applicable only for cameras which require manual shutter cocking, proceeds as above, except that the cocking lever is advanced and held so that it does not return. The shutter is tripped, and the cocking lever allowed to return slowly, held back by finger pressure, allowing the shutter to go slowly through its cycle. The exact point of contact closure in the shutter cycle is indicated by the strobe flash. Thus, knowing where in the shutter cycle the contact closure occurs, the photographer can estimate approximately how much delay is allowable between this closure and the strobe flash before the shutter closes. For example, if the contact closure occurs at point A (Figure 4-9), a delay which is almost as long as the indicated exposure time itself is allowable. With certain shutters, contact closure can occur later than point A, thus reducing the amount of allowable delay time.

The camera used should have "X" synchronization, necessary with most types of electronic flash illumination.

The camera should not be loaded with film until consistent synchronization is observed, because normal variations in shutter speed and flash contact operation may cause erratic results if the light flash occurs too close to the shutter opening or closing. Uneven exposure will result if the shutter blades are only partially open during the light flash, and the film will be completely dark if the flash occurs either too early or too late.

Cameras with focal-plane shutters are usually limited in high ambient light conditions, because the film frame must be completely uncovered for exposure at the instant the light flash occurs. Most focal-plane shutters do not expose the entire film frame at one time, except at slow shutter speeds (anywhere from 1/60th to 1/125th of a second) or when operating in the "Bulb" or "Time" mode. The "open Flash" method of taking strobe pictures, described in paragraph 4.7, should always be kept in mind by the photographer, as it is the easiest method from the synchronization standpoint, and it can be employed with almost *any* camera.

## section 5

# SYNCHRONIZATION

### 5.1 GENERAL.

Probably the most difficult problem facing the high-speed photographer is the task of synchronizing the strobe light flashes with his subject's motion in order to expose his film at the desired time. If the flash is either too early or too late, the subject will be "stopped" in the wrong position, and the resulting photograph will be useless. In the most difficult case, that of high ambient light conditions, synchronization consists of three tasks: first to see to it that the subject is in the proper position; second, to open the camera shutter, and third, to flash the stroboscope.

If the photograph can be made in a darkened location (refer to paragraph 4.6 for a discussion of the effects of ambient light on high-speed photography), only the strobe flash must be synchronized with the event, as the camera shutter can be left open during the entire cycle of the subject in motion to await the flash of the stroboscope. The following paragraphs describe various means of performing synchronization.

### 5.2 RECOGNIZING THE EVENT: VARIOUS MEANS OF TRIGGERING THE SYNCHRONIZATION SEQUENCE.

**5.2.1 MANUAL TRIGGERING.** Under low ambient-light conditions, the motion of a repetitive event may be "frozen" by illumination with a stroboscope flashing at the event frequency (or a submultiple) and a photograph made by simply tripping the camera shutter at any time. Exposure, difficult to determine other than by trial and error, depends on the f-stop and the number of flashes which occur while the shutter is open. However, the cyclic speed, path and orientation of the moving object must not vary if this method is to prove practical. Blur caused by instability of the subject speed may be minimized by use of the shortest possible shutter speed.

5.2.2 MECHANICAL CONTACTS. Mechanical contacts, the most easily employed triggering device, are suitable for both nonrepetitive and repetitive motion. The main drawback of mechanical contacts is their tendency to produce spurious flashes due to contact bounce. Normally open contacts are less satisfactory than normally closed contacts because they are more likely to have these bounce problems. Expendable contacts may be made of wire or aluminum foil in either configuration. A few examples of mechanical contacts are: a wire that is broken by the motion of the subject which, in turn, opens or closes an electrical circuit, e.g., a wire carrying current cut by a bullet; two pieces of aluminum foil, to which current-carrying wires are attached, which the subject presses together; and a thread attached to the subject used to pull the firing switch of the camera. There are many other triggering techniques. Photographers of ballistics often use a paper that has a metal foil coating on both sides. Triggering occurs when the projectile passes through the paper and makes contact with both foil coatings.

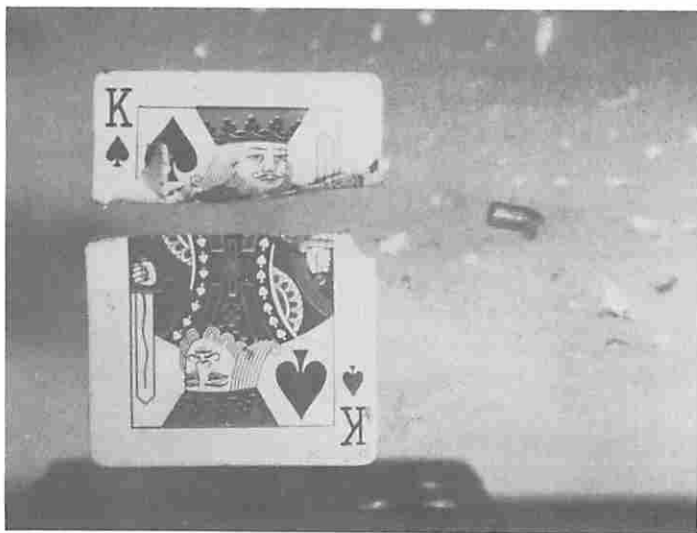

Figure 5-1. A playing card being split by a .22-calibre rifle bullet traveling at approximately 1150 feet per second. Note how the slug has tipped and started to tumble from contact with the card.

This action was photographed with a single high-intensity flash from a 1531-A Strobotac® electronic stroboscope. The reflector was removed, and the flash lamp was located about 14 inches from the subject. To trigger the flash, a microphone was placed forward of the rifle muzzle and connected to the Strobotac through a small voltage amplifier. The camera lens (135-mm Schneider, with a Kodak PORTA +3 close-up attachment) was set at f/8 and located about 10 inches from the card. (Polaroid Type 47 film, 3-microsecond exposure.)

Special pencils with electrically-conductive lead have been used to draw trigger contacts. Conductive inks and paints for printed circuit work can also serve as elements of triggering devices. Switches that are actuated with a small force (microswitches, mercury switches, etc.) can be used. However, any contact mechanism should be made small enough to minimize any loading effects on the subject. Figure 5-1 shows a situation in which mechanical-contact synchronization is not feasible because of the loading effect of the triggering device. Figure 5-2 illustrates a practical application of mechanical contact synchronization.

Where cyclic motion is associated with the event, rotary contactors (usually found on larger machines where they cause negligible mechanical loading) may be used. Such a device is the General Radio Type 1535-B Contactor (shown in Figure 5-2), which, when attached to a rotating shaft, triggers any General Radio stroboscope.

The Contactor will trigger on either contact opening or contact closure. The contact may be rotated about the shaft, so that the phase of flash with respect to the event may be adjusted. Contact bounce, which causes spurious flashing, usually sets the upper limit of the flash rate, which is about 1,000 rpm.



Figure 5-2. 1535-B Contactor in use with Strobolume.



**5.2.3 OPTICAL PICKUP.** The optical pickup, which generates an electrical signal when a change in illumination occurs, has become a popular synchronizing device with the advent of fast, relatively inexpensive solid state photosensors. Such devices may be used over extremely wide speed ranges, have no bounce problems, cause no physical loading, and may be very sensitive, so that they can be located at relatively large distances from the subject. Examples of commercially available optical pickup systems are the GR 1536 Photoelectric Pickup in combination with either a Strobolume and 1540-P4 Oscillator Delay Unit or the 1531-P2 Flash Delay (used with the 1531, or 1538 Strobotac or 1539 Stroboslave), and the 1537 Photoelectric Pickoff (used with the 1538 Strobotac or the 1539 Stroboslave). The 1536 Photoelectric Pickoff contains a light source, a concentrating lens, and a photocell all in a small cylinder that is mounted on an adjustable stand. The 1537 Photoelectric Pickoff has no internal light source, and its photosensitive element is a light activated silicon controlled rectifier. Both devices operate to 2500 pulses per second. The Pickoff-Flash-Delay combination mentioned has the advantage of a built-in time delay between light pulse and trigger signal. This system shown in Figure 5-3, will be described more fully in paragraph 5.3.1.



Figure 5-3. Strobotac/Flash Delay/Photopickoff combination.

The two common techniques for optical triggering are illustrated in Figure 5-4. A lens may be required in front of the cell to increase

its apparent sensitivity. Semiconductor cells respond more quickly to a pulse of light than to a pulse of "dark". Pickup by the cell of stray light, such as light from the strobe flash may cause erratic triggering. Strategically placed cardboard shields or an alternate pickup position or angle will usually eliminate these problems. Insufficient contrast between the target and the background will make triggering difficult. To obtain the most reliable and consistent triggering from a photoelectric pickoff, a sharp discontinuity in reflectivity should be used as a trigger point on the subject. Small markers made from Scotch brand Silver Polyester Film Tape No. 850 or reflective metallic foil make ideal trigger marks, and on-dark surfaces white or silver paint is sometimes satisfactory. Dark backgrounds may be made nonreflective by painting with flat-black paint available at photographic stores. Triggering problems are often materially reduced by a change in the distance between the pickup and the target; experimentation will reveal the optimum separation.

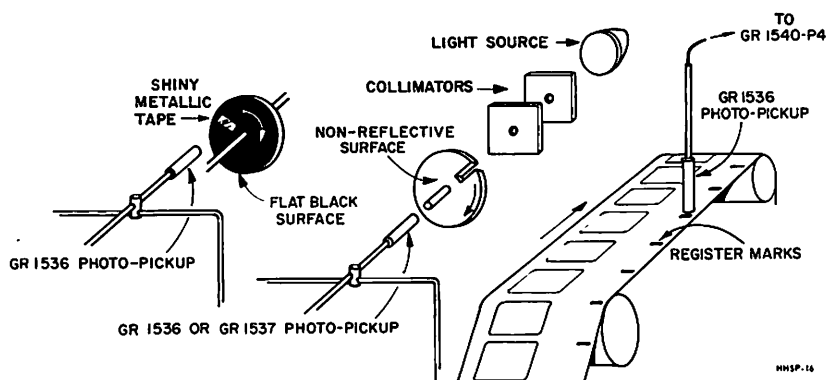

Figure 5-4. Optical triggering techniques.

When a separate light source is used, the intensity should be at the minimum level required for reliable triggering. This is especially important if the triggering marker is dark. If a subject is to interrupt a light beam aimed at the pickup (particularly when the pickup contains a light-gathering lens), the light beam may be collimated by passing it through a number of cardboard baffles containing small diameter holes to ensure that it will have a diameter smaller than the subject face dimensions. It should be pointed out that a Strobolume with a 1540-P4/1536 combination will trigger on a "dark" as well as a light or reflective surface (see special case, Figure 5-4).

**5.2.4 DIRECT ELECTRICAL TRIGGERING.** It is sometimes possible to utilize an electrical signal associated with the event for syn-

chronization. For instance, the motion of a device powered by a synchronous motor may be "stopped" with stroboscopic light by triggering the flash with the ac line voltage. The practicality of this method is determined by the triggering characteristics of the particular strobe used. If electrical noise is present in the form of spikes or transients, false triggering may occur, but harmonic distortion is usually not a problem if relatively high levels of input signal are employed. A small coupling capacitor (about  $0.1\mu\text{F}$ ) in series with the strobe input terminal is necessary if the strobe units will not trigger properly when dc is present on the input signal. The same capacitor may be used when the small dc component at the strobe input interferes with the operation of the signal source.

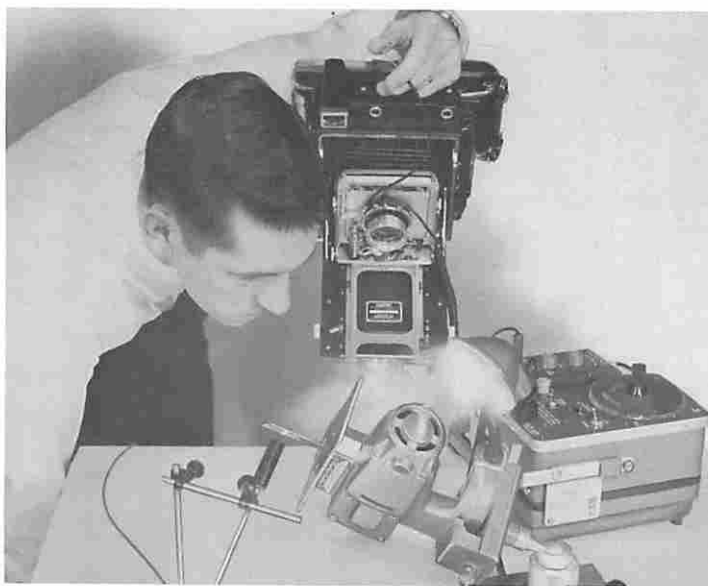

Figure 5-5. Typical photographic setup illustrating the use of the photoelectric pickup.

**5.2.5 PROXIMITY PICKUP TRIGGERING.** Devices which generate an electrical signal when an object passes close by may be built or bought by the photographer of high-speed machinery. These devices, called proximity pickups, are usually magnetic and require the triggering object to be a magnet (when a magnetic pickup consisting simply of a coil of several thousand turns of wire is used) or to be a ferromagnetic material such as iron or steel (when a "variable reluctance"

pickup is used). Figure 5-6 illustrates the operation of these pickups. The strength of the signal generated by these devices depends on the subject speed and distance from the pickup. There is strong physical attraction between the pickup and the subject. The widely available proximity device is best suited to applications where it may be permanently mounted at an accurately controlled distance from the subject. An iron patch mounted on a nonferromagnetic rotating shaft such as the one in Figure 5-6a is an example of this type of application. A variable reluctance pickup could be mounted near an iron or steel gear, whose passing teeth will generate a signal. For low speed applications, it is possible to build satisfactory pickups, such as the one in Figure 5-6b, using parts from sensitive electrical relays. Commercially made proximity pickups may be obtained from Airpax Electronics Incorporated, Seminole Division, Fort Lauderdale, Florida or from Electro Products Laboratories, Inc., Chicago, Illinois 60648.

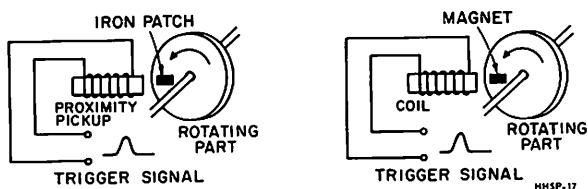

Figure 5-6. Triggering by proximity pickups.

**5.2.6 ACOUSTIC TRIGGERING.** The sound associated with the event to be photographed may be detected by a microphone to provide synchronization. This type of sensing is reliable for loud noises and easy to set up, and it does not load or otherwise interfere with the subject. The separation between the microphone and the sound source may be adjusted to vary the trigger delay. This delay, approximately 0.9 millisecond per foot of separation, is quite stable and is adjustable over a very wide range. An amplifier is usually required to increase the microphone output to a usable level. (Any amplifier, for instance, a high-fidelity amplifier might work.) The sound of the event must contrast sharply with any background noise to prevent spurious triggering. To effect this, the amplifier gain, normally controllable over a wide range, can be set to a level at which the noise is rejected and only the signal causes triggering. Figure 5-8 shows a typical acoustic triggering setup.

To minimize the amount of fixed delay introduced into the system and to achieve maximum delay stability the microphone should be arranged so that positive pressure on the microphone's diaphragm causes the correct output trigger polarity. The photographer will have to deter-

mine the proper attachment of the leads to the microphone by calculating the microphone-subject distance, setting the appropriate delay, and taking the picture. If the subject is not in the picture field, reversing the leads may help.

SLAVE MASTER	Type 1531-A Strobotac electronic stroboscope	Type 1538-A Strobotac electronic stroboscope	Type 1539-A Stroboslova	Type 1540 Strobolume	1540-P3 Slave Control Unit	Type 1531-P2 Flash Delay
Type 1531-A Strobotac electronic stroboscope	Type 1531-P4	Type 1531-P4	Type 1531-P4	Type 1531-P4		Type 1531-P4 and 1531-0461
Type 1538-A Strobotac electronic stroboscope	Type 1560-P76	Type 1560-P76	Type 1560-P76	Type 1560-P76 or 1541-9601		Type 1560-P76 and 1531-0461
Type 1540 with 1540-P1 or 1540-P4 Control Unit	Type 1560-P76 or 1541-9601	Type 1560-P76 or 1541-9601	Type 1560-P76 or 1541-9601	Type 1560-P76 or 1541-9601		Type 1531-0461 & Type 1560-P7 or 1541-9601
Type 1531-P2 Flash Delay	No cord needed.	No cord needed.	No cord needed.	No cord needed		Type 1531-0461
Type 1536-A Photo Pickup						No cord needed.
Type 1537-A Photo Pickup		No cord needed.	No cord needed.	No cord needed		
Type 1535-B Contactor	No cord needed.	No cord needed.	No cord needed.	No cord needed		

Cords required for various interconnections of General Radio stroboscopes and triggering devices.

TABLE 5-1.

### 5.3 PROCESSING THE TRIGGER SIGNAL.

In most cases, even when ambient light level is low, the sensitivity of the event by devices such as those listed above is only half the battle. The minimum requirement is usually an amplifier that will raise the generated signal to a usable level. Other devices that might be needed are: a filter or a logic circuit to prevent unwanted flashes caused by extraneous signals; a pulse transformer to reverse the polarity of the input pulse in case the signal pulse has the wrong sign for the stroboscope used; and an instrument capable of introducing a controllable delay time between the event-trigger and shutter-flash sequence. Devices that will perform one or all of these signal-processing functions can be constructed or may be purchased. One such device is the GR 1531-P2 Flash Delay unit, which performs all the above-mentioned functions – amplification, pulse inversion, filtering, and delay-introduction. (See Figure 5-7.) The 1540-P4 Oscillator/Delay Control Unit used with the Strobolume (see page 24) also performs similar functions.

**5.3.1 THE TYPE 1531-P2 FLASH DELAY.** The Flash Delay may be used with the 1536-A Photoelectric Pickoff to trigger a stroboscope in synchronism with a given point in the cycle of a moving object. The delay times available with the 1531-P2 are continuously variable from 100 microseconds to 1 second. Probably the most common application

for the Flash Delay and Photoelectric Pickoff is in the observation and photographing of the various phases of high-speed repetitive phenomena. When the Strobotac has been synchronized with the subject's motion (e.g., the rotation of an electric fan's blade), its motion is "stopped" so it appears to be stationary. Then as time delay is inserted into the triggering circuit, the subject is illuminated at a slightly later time in each cycle, and thus appears to "slip" forward in position (e.g., if the fan is actually rotating clockwise, it will appear to turn clockwise slowly as the time delay is increased).



Figure 5-7. 1531-P2 Flash Delay.

The MULTIPLE/SINGLE-FLASH switch on the Flash Delay can be used to take single flash photographs of repetitively moving objects in any desired position. The shutter speed must be slow enough so the shutter is open for at least one complete cycle of the moving object. When the switch is in the MULT position, a delayed light flash occurs for each trigger pulse applied to the Flash Delay INPUT jack. If the toggle switch is set to the SINGLE FLASH position, the train of delayed trigger pulses being fed to the Strobotac is interrupted, and the light flashes cease. A single flash can then be obtained by closure of a set of contacts (in this case the camera-shutter flash-synchronization contacts) connected to the small jack mounted near the Flash Delay power cord. This light flash follows the next trigger pulse received at the unit by the preset amount of time delay, so the subject is illuminated in the same phase of its cycle that was visually observed when the switch was in the MULT position.

An auxiliary switch and cable can be used if available cameras are not equipped with "X" synchronization. In this case the shutter

must be set to "Bulb", the Strobotac flashed by closure of the switch, and then the shutter closed.

The Flash Delay can be operated directly from the Photoelectric Pickoff through connection to the Flash Delay INPUT jack. Other signal sources may also be used in lieu of the Photoelectric Pickoff, provided that they deliver positive pulses of at least 0.3-volt amplitude to the Flash Delay. The Type 1531-0461 Adaptor Plug furnished with each unit, makes possible the use of a standard two-wire telephone plug to make the connection. Use of the adaptor prevents instrument damage when electrical triggering devices are connected to the Flash Delay. The adaptor may be left plugged in to prevent accidental insertion of a two-conductor plug directly into the INPUT jack.

The 1531-P2 Flash Delay can be used with any type of triggering device capable of producing a 0.3-volt electrical signal. For example, Figure 5-8 shows the Flash Delay employed in an acoustic synchronizing system.

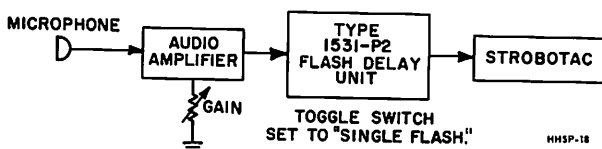

Figure 5-8. Acoustic triggering.

There are two ways a 1531 Strobotac may be triggered through the Flash Delay with a simple contact closure. If minimum time delay is desired between a contact closure and the light flash, the contacts are connected to the jack near the Flash Delay power cord and the RANGE switch is set to EXT. Camera shutters equipped with "X" flash synchronization contacts can be used in this manner to trigger the stroboscope directly. The 1538 Strobotac and the 1539 Stroboslave can be triggered directly by contact closure – no Flash Delay unit is required, unless a delayed flash is needed.

An alternative method permits the full range of delay to be utilized while the 1531 Strobotac is triggered from a contact closure. The circuit shown in Figure 5-9, which can be readily constructed from parts available in any radio supply store, is simply plugged into the Flash Delay INPUT and the trigger contacts are then connected to this circuit, as indicated. This method can be used with the shutter contacts on cameras that delay the shutter opening intentionally after the built-in contacts close to allow sufficient time for flash bulbs to reach peak light output. (The delays provided by common flash-synchroniza-

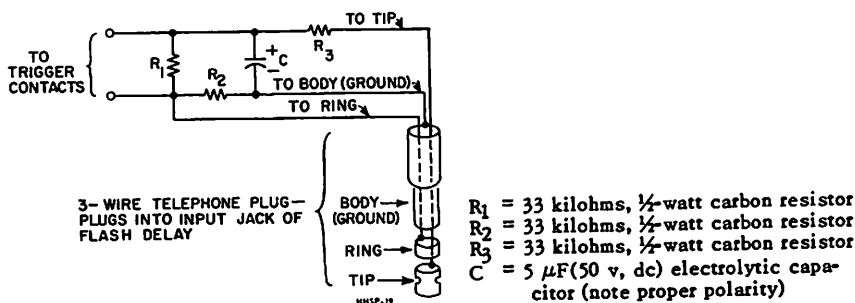

Figure 5-9. Contact-delay circuit, for triggering the Flash Delay by a contact closure with full range of time delay available.

tion settings are listed in Table 5-2.) Since the Strobotac delivers its peak light intensity immediately upon triggering, the built-in camera delay at "F" and "M" flash settings causes the Strobotron lamp to fire before the shutter is fully opened. Consequently, the trigger signal that will cause the Strobotac to flash must be delayed appropriately if a camera equipped only with these synchronization settings is to be used. A delay of approximately 4 milliseconds, for example, should be used with most inexpensive universal-focus cameras, as these cameras are usually equipped for "F"-type synchronization.

TABLE 5-2.  
Time Delay Required in Trigger Circuit  
for Various Shutter Synchronization Settings

Shutter Synchronization Setting	Approximate Time Delay Between Contact Closure And Full Shutter Opening
"X"; XS	0 ± 1 millisecond
"F"	3 milliseconds, nominal; 5 and 2 milliseconds maximum and minimum
"M"	15 ± 2 milliseconds

Fully adjustable synchronized shutters provide both a zero delay and an adjustable delay range from 5 to 19 milliseconds.

The appropriate delay time for the shutter being used should be roughly set into the Flash Delay by means of the DELAY control. Then, while visually checking the shutter-flash synchronization, as outlined in Section 4-7, make a fine adjustment. Again, consistent synchronization should be observed before film is loaded into the camera.



**5.3.2 OTHER SIGNAL PROCESSING DEVICES.** If only one or two simple processes are needed to modify the signal for use with a particular stroboscope, it will probably be most economical to build a device suited to the particular situation faced by the photographer. For example, only a contact closure may be available to trigger the 1531 Strobotac which requires a contact-opening signal with zero delay. A simple inverting circuit will be required, such as that diagrammed in Figure 5-10. The necessary parts can be purchased for less than \$2.00, and only a few minutes are required to assemble them. Contacts in camera shutters equipped for X synchronization normally operate satisfactorily with this circuit, but some difficulty may be experienced if the contacts bounce when closing. A small capacitor (around 0.01 microfarad) connected externally across the contact terminals usually solves this problem.

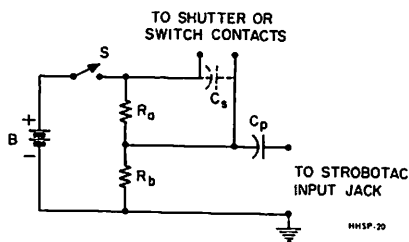

- B - 12-volt (or greater) battery
  - $R_a, R_b$  - 1-megohm,  $\frac{1}{2}$ -watt carbon resistors
  - S - SPST ON-OFF switch
  - $C_s$  - Optional capacitor to prevent multiple triggering from contact bounce. Start with about 0.01  $\mu F$  (100 V, dc) and increase capacitance until only one flash is triggered from each contact closure.
  - $C_p$  - 0.01  $\mu F$ , 100-volt capacitor
- NOTE: Set RPM dial fully clockwise.

Figure 5-10. Circuit for triggering the Strobotac by a contact closure with minimum time delay.

The internal delay characteristics of the General Radio Strobotac electronic stroboscopes can be used to introduce a variable delay between a negative or contact closure input signal and the flash. This method of obtaining a time delay, however, is not time stable and may introduce appreciable time jitter; for this reason, use of the Flash Delay is preferred. The delay varies from approximately 20 milliseconds with the RPM dial fully counterclockwise to 300 milliseconds with the dial at a point approximately  $90^\circ$  away from fully clockwise. As the RPM dial is swept past this point, the flash will fire without being externally triggered. At the full clockwise end of the dial, zero delay will occur. These flash-delay characteristics are summarized in Figure 5-11.

It is usually necessary to provide phase adjustment within the picture-taking system, so that the subject is in the proper position when the lamp is fired. The easiest way to do this is to use a device

such as the 1531-P2 Flash Delay to introduce a variable time delay between the trigger signal and the strobe flash. Such a device may be used with repetitive events to stop the motion as explained in paragraph 5.3.1, or with non-repetitive events to ensure that the strobe flash occurs when the subject is in the proper position. For example, to take the milk-drop pictures of Figure 1-3, the photographer used a photoelectric pickoff to produce a synchronizing pulse for the Flash Delay. Then by varying the delay he could photograph any part of the drop's descent.

Another type of phase adjustment is obtained by varying the position of the signal-producing device itself. For example, by changing the subject to microphone distance in the acoustic triggering system mentioned earlier, a variation of the occurrence in time of the flash is obtained.

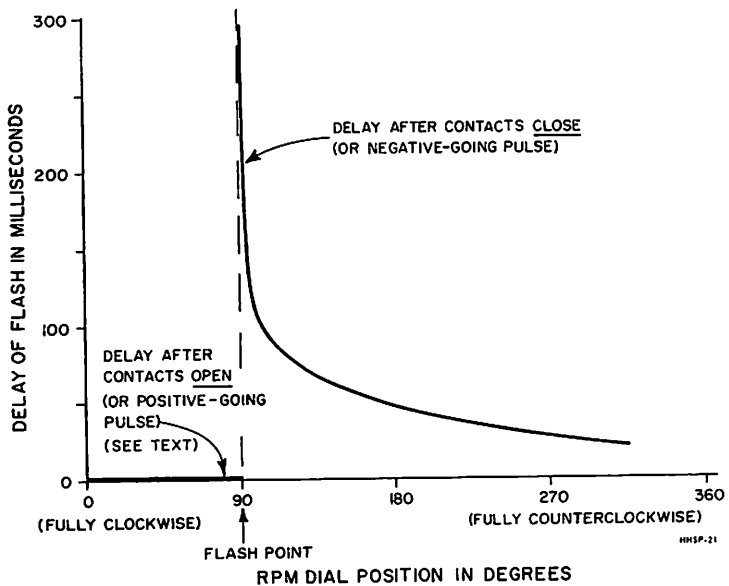

Figure 5-11. Internal delay characteristics of the Type 1531-A Strobotac electronic stroboscope.

**5.3.3 OBTAINING A FLASH BURST FOR A MULTIFLASH PHOTOGRAPH.** In many cases the stroboscope with its free-running internal oscillator may be employed to take a multiple-flash picture, in which several exposures are made on a single piece of stationary film. Other

applications require the burst to be synchronized with the event. Two convenient methods for generating a flash burst are illustrated in Figure 5-12. The time separation between flashes is determined by the flash-interval setting, and the number of flashes may be set to any discrete number up to 16. The subject may initiate the burst by any of the triggering techniques previously described. The burst system is armed when the camera's shutter contacts are closed and the burst sequence is initiated by some external trigger. Care must be exercised to assure the shutter time selected will be long enough to capture all the flashes.

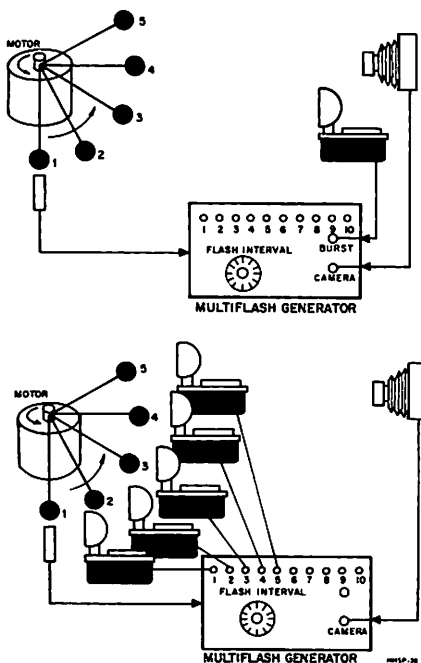

Figure 5-12. Two methods for taking multiflash photographs. (A) shows one strobe fired in a burst manner from a GR Type 1541 Multiflash Generator, and (B) shows multiple strobes being fired in sequence. A description of the 1541 may be found on page 92.

If the event to be photographed occurs over a large area or is happening so rapidly that the maximum flash rate of the stroboscope when set at the desired intensity is not fast enough, several stroboscopes may be flashed in sequence. A scheme for connecting multiple stroboscopes is shown in Figure 5-12(B). This technique permits the use of the maximum intensity settings of the stroboscopes (see Figure 4-3) at effective flashing rates of up to 100,000 flashes per second. An alternative method for multiple-strobe burst flashing is shown in Figure 5-13. The Flash Delay units insert a minimum delay of 100 microseconds between the flashes of two successive stroboscopes.

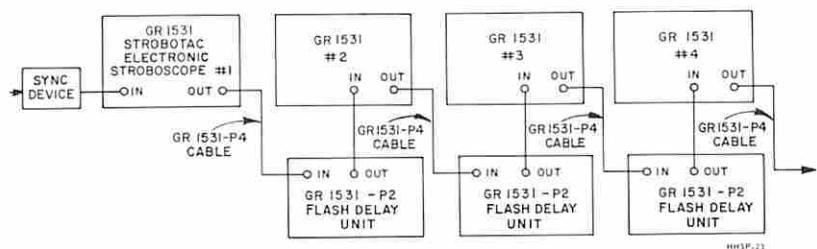

Figure 5-13. System for generation of a multflash burst.  
All Flash Delay units are adjusted for equal delay.

Since the Flash Delay is uncalibrated, an oscilloscope with a calibrated time base or some other precise timing device will be needed if it is necessary to flash the stroboscopes at precisely timed intervals. If minimum delay between flashes is desired, the stroboscopes may be connected to each other directly. The General Radio line of stroboscopes may be interconnected directly via special cables provided as accessories for the various instruments. Table 5-1 indicates what connectors are required for all possible interconnections.

#### 5.4 TAKING A TYPICAL HIGH-SPEED PHOTOGRAPH.

To summarize and illustrate the complete process of taking a picture of a high-speed event, here is a typical industrial situation: a photograph of the spindle (Figure 5-14) of a "false-twist" textile machine is to be made to study the yarn as it passes around the transverse (horizontal) pin. The spindle, which is  $3/16$  inches in diameter, rotates at the rate of 250,000 rpm.

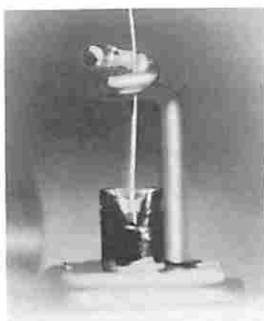

Figure 5-14.  $3/16$ "-diameter spindle of a "false-twist"-textile-machine. Speed, 250,000 rpm.

The required equipment is shown in Figure 5-15. A photoelectric pickoff is employed because of the high speed and low mass of the subject. The Flash Delay Unit powers the photo pickoff and permits single-flash exposure at any desired position of the spindle rotation. The second strobe, shown slaved to the first, may be used to increase the total available light and to render a more balanced exposure. A 4 X 5 press camera with a 150-mm lens and 18-inch bellows extension capability is used so that Polaroid test pictures and negatives may be

made with the same camera without readjustment. Use of full-bellows extension will produce an image magnification in the camera. High-speed films are employed to permit a minimum aperture setting for maximum depth-of-field and/or shorter flash duration for reduced blur.

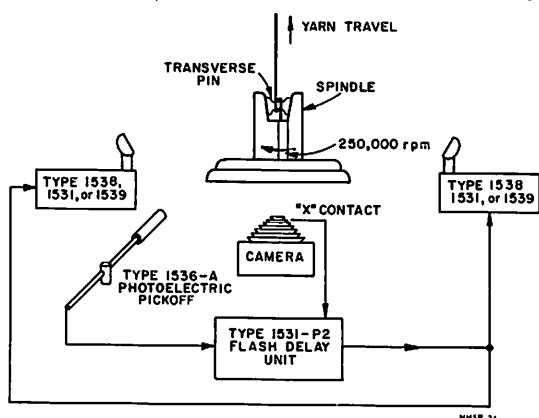

Figure 5-15. Setup used to photograph false-twist spindle.

**DETAILED PROCEDURE.** The system is assembled as indicated in Figure 5-15 and tested for proper operation. The photo pickoff generates the synchronizing signal directly from a reflective stripe on the spindle. Reflective tape is not suitable here because of the centrifugal force to which it would be subjected. The spindle is polished with crocus cloth and all but a narrow strip blackened with a felt-tipped marking pen. With the Delay Unit toggle switch at MULTIPLE, the pickoff is positioned near the spindle to provide reliable triggering. The camera is set up and focused, and the delay adjusted to orient the spindle properly. The blur angle to be expected may be calculated as follows for 3-microsecond flash duration:

$$\frac{250,000 \frac{\text{revolutions}}{\text{minute}}}{60 \frac{\text{seconds}}{\text{minute}}} \times 360 \frac{\text{degree}}{\text{revolution}} \times 3 \times 10^{-6} \text{ sec} = 4.5^\circ$$

The blur angle will be correspondingly smaller for shorter flash durations, but since the photograph is of a "face" of the spindle, the calculated blur is perpendicular to the plane of the film and is negligible.

Test pictures may first be taken using a Polaroid adaptor loaded with ASA 3000 (type 57) film. The corresponding guide number for the 1538 Strobotac operating in the high-intensity range is 90 (from Figure

4-3). If the reflectors are placed 6 inches from the spindle the effective separation is 2.0 feet. The bellows-extension correction is determined from Figure 4-5.

$$\text{Bellows Ext.} = \frac{25.4 (18)}{150} \approx 3, \quad \text{Image Size} = 2,$$

and the correction factor  $K \approx 0.3$ .

The addition of a second lamp complicates the calculation, but a reasonable first-order guess is that it will cause  $\sqrt{2}$  (a 40%) increase of  $f/\text{number}$ . The calculated  $f/\text{number}$  would be:

$$f = (0.3) \frac{90}{2} (1.4) = 18.9,$$

which can be approximated, or the nearest indicated number ( $f/16$  or  $f/22$ ) may be used.

A final consideration is the shutter speed. This must be fast enough to prevent ambient-light exposure, which appears as blur and reduced contrast in the final photo. The shutter must be fully open for at least a full cycle of the spindle (see paragraph 5.3.1). In this case, one revolution takes

$$\frac{1}{\frac{250,000}{60}} \approx \frac{1}{4,000} \text{ sec}$$

and the between-the-lens shutter speed may be the fastest indicated (e.g.  $\frac{1}{400}$  sec).

The required  $f\text{-stop}$  must be calculated for pictures to be taken on negative film. In this example Kodak Royal-X Pan film with an ASA rating of 1250 is used. The required camera  $f\text{-stop}$  is:

$$f = (0.3) \frac{55}{2} (1.4) = 11.5$$

If depth-of-field is unimportant, a finer-grained, slower speed film can also be employed with correspondingly lower  $f\text{-stop}$  setting.

## **section 6**

# **MOTION-PICTURE PHOTOGRAPHY**

### **6.1 USE OF A MOVIE CAMERA.**

It is often desirable to have more information about the subject than can be obtained from a single or multiframe exposure, particularly when the subject "doesn't get out of the way of itself" for successive exposures, as described in Section 1.3. In such cases, a motion picture of the event may supply this information. A movie is merely a series of still pictures taken at different instants in time. The movie camera just allows these still pictures to be taken in succession, more rapidly than is possible with a roll or cut-film camera. The advantages of stroboscopic illumination for motion pictures are similar to those for photography, and most of the techniques and considerations discussed in the foregoing sections apply equally to both photographic methods.

The type of camera to be employed will depend upon the nature of the event. In general, a conventional movie camera may be used to photograph repetitive subjects, such as rotating or vibrating parts, regardless of the subject speed. A high-speed movie camera must be used to photograph transient events, such as projectiles in flight or destructive processes.

### **6.2 CONVENTIONAL MOVIE CAMERAS.**

The ability of the stroboscope to act as an electrically operated high-speed shutter makes it useful with any full-shutter movie camera including the least expensive amateur models, even where there is no camera-strobe synchronization. Best results are obtained when the stroboscope's flash rate is many times the camera framing rate (six times the framing rate or more). Lower flash rates will result in intensity flicker or blank or partially masked frames. A disadvantage of the unsynchronized technique is that exposure can only be determined by trial and error.

The versatility of this photographic system is considerably increased if the camera is equipped with a contactor which synchronizes the shutter with the stroboscope's flashes (see Figure 6-1). The *effective* high shutter speed of a strobe triggered directly by the contactor produces images devoid of the blur one gets when the camera's relatively slower shutter is used with conventional photo lighting. This

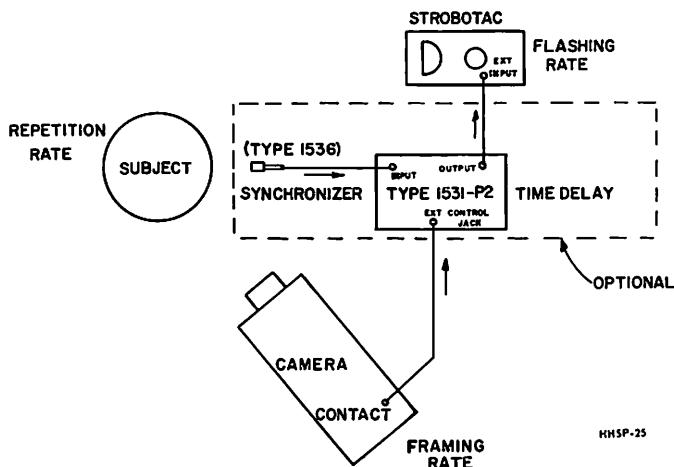

Figure 6-1. Synchronization of a movie camera's shutter to a stroboscope.

improved clarity is important where there is to be a detailed frame-by-frame analysis as in the model-airplane vibration study in Figure 6-2. The determination of exposure for the synchronized system with its single-flash per frame is simpler than for the unsynchronized system. If the framing rate is variable, the frames-per-second control on the camera (instead of the strobe internal oscillator) may be adjusted to produce synchronization of the subject and stroboscope. The framing and flash rates need not be at the subject frequency; identical pictures result if the subject frequency is an intergral number of times the framing rate, as in Figure 6-3. A slower framing (and flash) rate permits a higher strobe-intensity setting.

If slow-motion sequences are to appear to "slip" at a specific rate when projected, the following correction must be made during filming:

Apparent

$$\text{"slip rate" while filming} = \frac{\text{Camera frame rate} \times \text{apparent "slip rate" while projecting}}{\text{Projector frame rate}}$$



The subject image will appear to move or jitter if the camera speed is not stable. The *rate* of this image jitter will increase (or decrease) depending upon the ratio of the camera and projector frame rates.

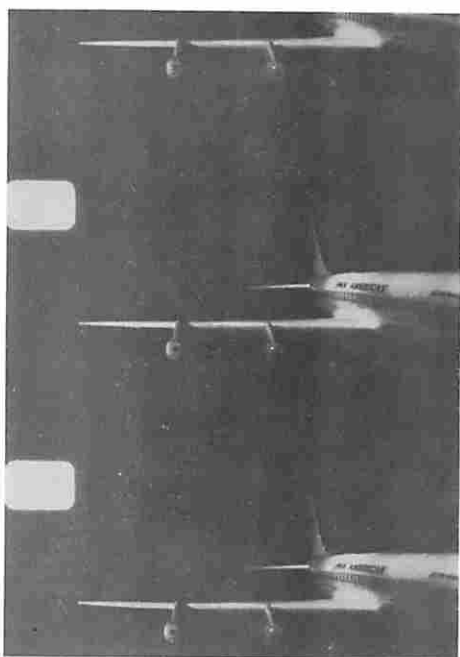

Figure 6-2. Movie of model airplane wing flexure resulting from vertical vibration at 190 cps. Camera framing rate is 16 frames-per-second.

The strobe may be synchronized to the camera and event by using a photo-pickoff and a Type 1531-P2 Flash Delay Unit as described in Section 5.3.1. This provides single-flash exposure of each frame when the shutter is open, allows any phase of the subject cycle to be photographed conveniently, and automatically adjusts flash rate to follow speed variations of the subject (see Figure 6-4). Remember that for most shutters (which are open 50% of the time and which are properly synchronized), the camera framing rate must not exceed 50% of the subject frequency if adequate allowable flash delay is to be provided so that all phases ( $360^\circ$ ) of the subject cycle can be examined (see Figure 6-5).

Unlike still cameras, conventional movie cameras are not supplied with internal mechanical contacts or other synchronizing means.

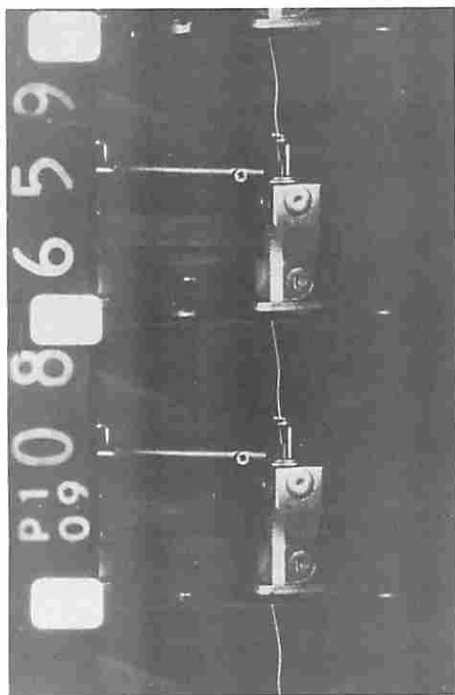

Figure 6-3. Leeson false-twist spindle rotating at 250,000 rpm. Photographed at 16 fps with Strobotac flashing once per frame.

A few manufacturers will supply this feature on special order. Modifications can be made on existing equipment by several photographic service organizations.

### 6.3 HIGH-SPEED MOVIE CAMERAS.

It is necessary to employ special high-speed cameras when successive events occur rapidly. Cameras such as the Fastax and Hycam move the film continuously rather than in jumps (framing) and use rotating-prism shutters. With continuous light the resulting film has evenly spaced images and is suitable for projection. Stroboscopic illumination with a high-speed camera provides an effective shutter speed which is much faster than that of the built-in mechanical shutter, and subjects photographed in this manner will contain less blur. Internal synchronizers are available for these cameras for use with stroboscopic illumination. Stroboscopes can also be synchronized to the film transports of some high speed cameras, by methods described in

Section 6.4. Photo- and reluctance-pickup triggering are best for this purpose. Strobe synchronization derived from the film transport is useful for both transient and repetitive studies.

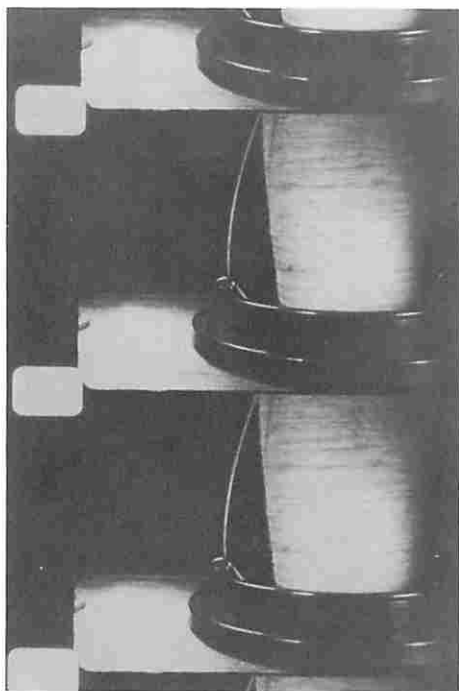

Figure 6-4. Ring winding yarn on textile spindle at 10,500 rpm. Camera framing rate is approximately 16 frames-per-second.

As the motor speed is usually variable on high-speed cameras, it may be practical to use this control to synchronize each frame with a given position of the subject and thus to take movies that show a moving object or operation as if stopped or moving in slow motion. At higher speeds this technique may be unsatisfactory, as much of the limited film capacity of the camera is wasted while film transport is accelerating and the operator adjusts the speed.

It is usually a simple matter to disable the shutter of a high-speed camera or lock it in the open position and then rely completely upon the stroboscope for effective shuttering. Such unsynchronized shutterless camera operation, with the flash rate set by the stroboscope's internal oscillator is useful for studies of both repetitive and

transient events. The desired flash rate may be set without running the camera and thus wasting film. Also, the flash rate may be set higher than the camera frame rate. This results in a series of images separated by very small time intervals – smaller intervals than can be obtained with the conventional shutter. This method effectively multiplies the normal maximum picture rate of the camera. Usually, more information can be obtained by this technique than from a regular multi-flash still picture.

#### 6.4 MOVIE CAMERA SYNCHRONIZATION.

For most straightforward applications, it is best to synchronize the stroboscope to the movie-camera shutter. Generally, conventional movie cameras do not come equipped with built-in means for synchronization; only some high-speed cameras have this provision (as an option). In most cases the means for synchronization must be added. These built-in synchronizers may be electrical contacts (not recommended for high-speed cameras), or reluctance or photo-electric transducers. The camera manufacturer should be consulted first to determine if a synchronizer is directly available. If not, a repair service specializing in camera modifications should be consulted to determine the feasibility of such an installation in the particular camera concerned. A few organizations are listed as a guide.<sup>1</sup>

The synchronizer must be compatible with both the camera in which it is to be installed and with the stroboscope it is to drive. The device must operate reliably and accurately – at the same point in the shutter cycle for each frame – if unexposed frames or apparent subject jitter are not to be a nuisance. The synchronizer phasing must be as shown in Figure 6-5. That is, the shutter must be capable of fully uncovering the film window, and the synchronizer must operate just after

---

1 Paillard, Inc., (Bolex) 1900 Lower Road, Linden, New Jersey 07036  
Arriflex Corporation of America, 25-20 Brooklyn-Queens Expressway  
(West), Woodside, L.I., New York 11377

Marty Forscher, Professional Camera Repair Service, 37 West 47th,  
New York, New York 10036

Martin Syrauss, 930 F Street, N.W., Washington, D. C. 20004

Mel Pierce, 6501 Hollywood Blvd., Hollywood, California 90028

Adolph Gasser, 5733 Geary Blvd., San Francisco, California 94121

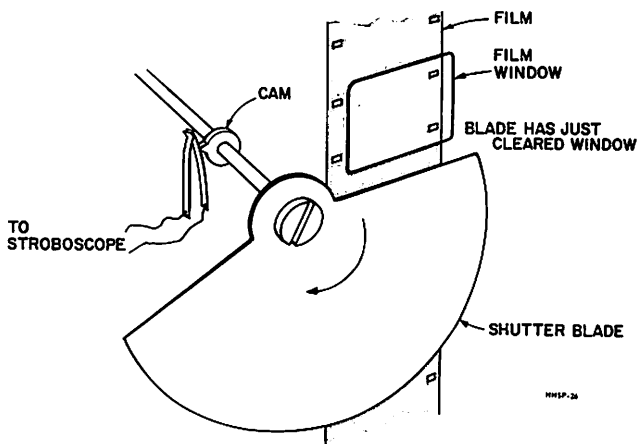

Figure 6-5. In a movie camera the synchronizing contact should be installed so that it operated once per revolution of the shutter blade, and just as the film window is fully uncovered.

the shutter is fully open. For a conventional movie camera, either mechanical contacts, a reed relay, or a photoelectric device may be a satisfactory synchronizer. With a photoelectric device, care should be exercised to eliminate internal light paths to the film chamber. A further disadvantage of photoelectric devices is the need for external power for the lamp and an amplifier for the photocell output. Cam-operated contacts are usually easiest to install, but may exhibit considerable bounce. The reed relay operated by a permanent magnet is a common compromise, though it lacks the desirable phase accuracy.

In high-speed cameras, the bounce problem tends to rule out the use of contact-type synchronizers. Reluctance pickups become useful, on the other hand, because their output voltage increases with increasing speed. A common technique is to place the reluctance pickup near the sprocket-wheel teeth (the sprocket must be a ferrous metal) to generate one sync pulse per frame. The phasing of the sync pulse with respect to the frame is adjusted by moving the pickup around the sprocket axis. If greater phase accuracy is required, a larger, external gear with appropriate number of teeth may be employed. Fast, miniature photoelectric devices which produce precise synchronization at the highest camera speeds are becoming popular. Internal installation

may be possible (possibly as manufacturer's option), or a shaft may be brought out of the camera to turn a disc with an appropriate number of reflective strips. A photo-pickoff such as the General Radio Type 1536 can then be employed.

## 6.5 SELECTING A CAMERA.

Although it is possible to use almost any conventional motion-picture camera for cinestroboscopy, most are not of instrument quality. For example, if the motor speed is not uniform, the subject may appear to drift or jitter badly (see *Suggested Camera Specifications for Cinestroboscopy*). Typical of an instrument-quality motion-picture camera is the Cinema-Beaulieu, distributed by Cinema-Beaulieu Inc. of New York, N.Y. It is a relatively inexpensive 16-mm camera with a reciprocating-mirror viewing system that allows the user to view the event through the lens before running the film. A variety of lens-mount systems for single and multiple lenses, and for automatic lenses, are available.

Characteristics to look for when selecting a camera for cinestroboscopy.

1. 16-mm format with 100-ft minimum film capacity or Super-S format.
2. Through-the-lens viewing system. Full-time viewing preferable, part-time acceptable.
3. Interchangeable lens mount accepting standard lenses.
4. Transport motor capable of non-stop exposure of entire film load.
5. Frame-rate continuously variable, adjustable at least over the range of 2 to 64 frames/sec.
6. Long-term speed (ignoring starting transient) not to vary (jitter) by more than 0.5%.
7. Short-term speed (ignoring starting transient) not to vary by more than 0.5%.
8. Film format to be completely uncovered by shutter for at least 50% of time. Shutter disconnect or lock-open feature desirable.
9. Built-in synchronizing device to produce a noise-free strobe-synchronizing signal over the entire frame-rate range. Photoelectric system acceptable.
10. Sync-signal phased to produce output when film window has just been uncovered by shutter, or just at the completion of film-advance cycle when lock-open feature is used.
11. Pin-registration desirable.
12. Pulse-drive motor (stepper) capability.
13. Capability for both normal cine and cinestroboscopic filming.

**HIGH-SPEED PHOTOGRAPHY** has many uses — esthetic, scientific, industrial. The photographs in these pages illustrate the rich variety of both subject and application.

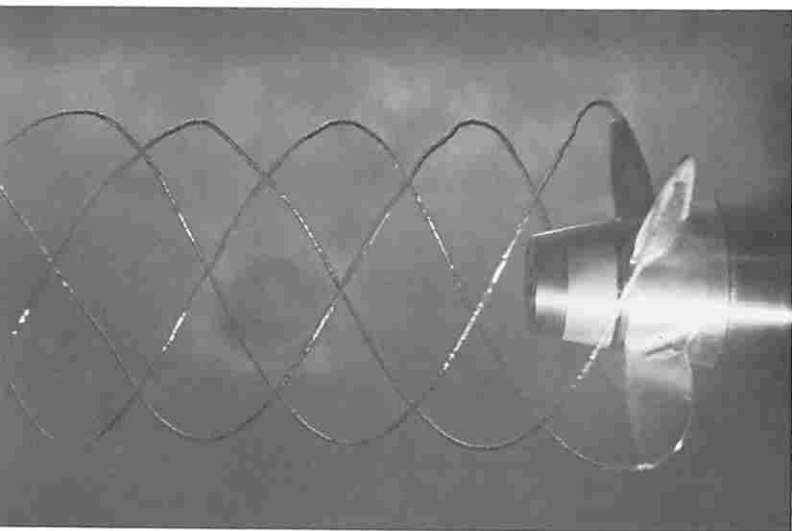

Underwater photographs of propeller cavitation in a test water tunnel. Photograph above shows well defined tip vortex cavitation on a single propeller. Photograph below shows cavitation on a pair of counterrotating propellers. Two Type 1532 Strobolumes were used as the light source. Camera was a 4" x 5" Graphic View II.

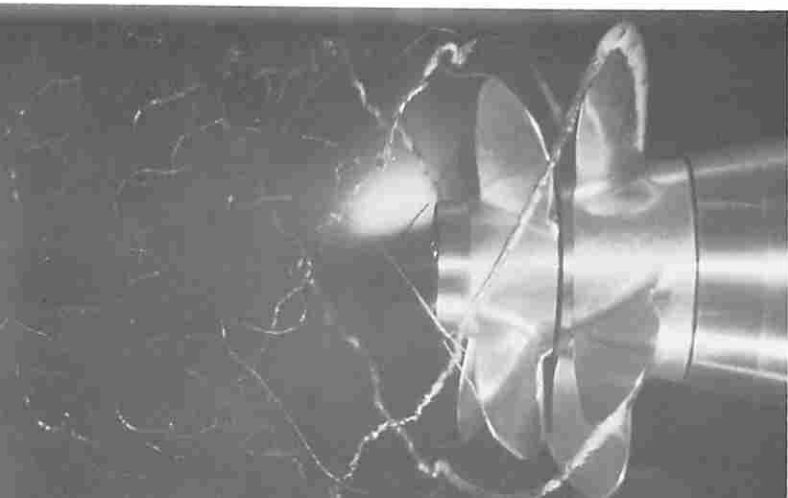

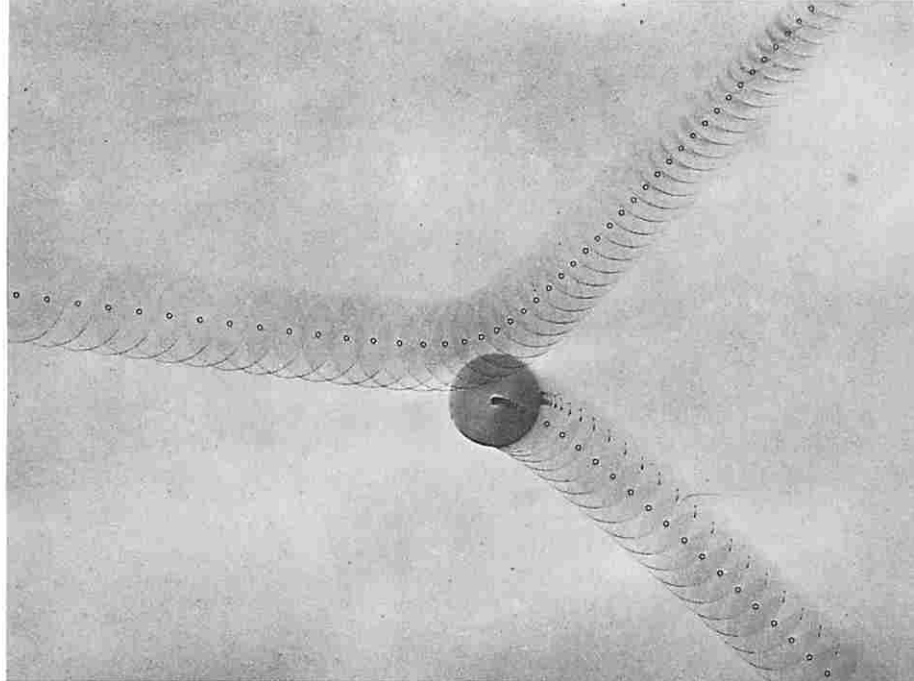

Sliding pucks containing cylindrical magnets oriented for mutual repulsion are used to illustrate the conservation of energy in elastic collisions. Photograph at top shows the reduction of speed and kinetic energy as one puck approaches the other, and analysis shows that this energy is stored in the magnetic field of the pucks. Photograph below shows the 'explosion' which occurs when the two pucks, originally held closely together by a string, are allowed to separate by burning of the string. Quantitative data obtained from analysis of the first photograph enabled a prediction to be made of the final kinetic energy produced by the experiment shown in the second photograph. Flashes here were at 0.1-second intervals. Used in the PSSC film *Elastic Collisions and Stored Energy*.





Use of dry-ice pucks on smooth, level surface and multiple-flash photographs to illustrate fundamental principles of physics in educational films. Courtesy of Educational Services, Inc., Watertown, Massachusetts.

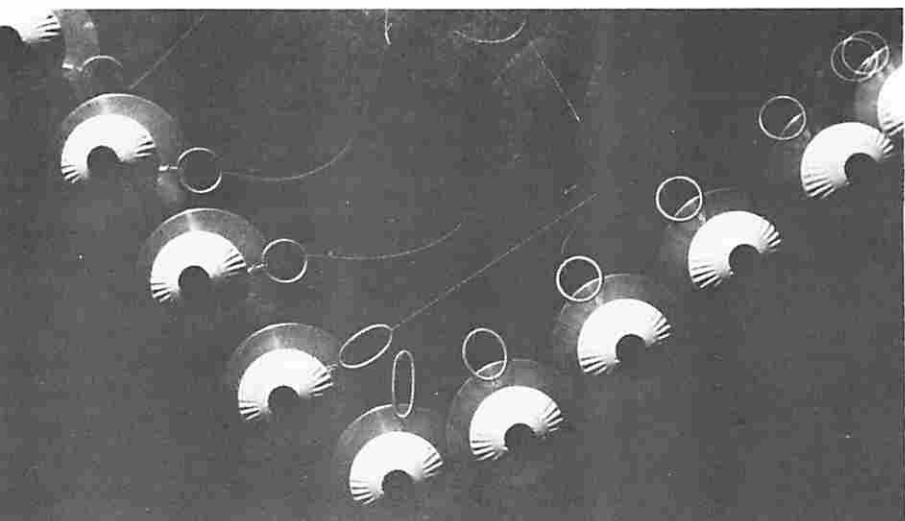

Sliding puck pulled by string at right angles to its direction of motion changes direction but not speed. String is fastened to puck by a rubber ring, which stretches when force is applied. Top photograph shows an abrupt change in direction caused by a brief pull on the string. Photograph below shows circular motion with a constant deflecting force (constant distortion of the rubber ring). Flashes were at one-second intervals. Used in the PSSC film *Deflecting Forces*.

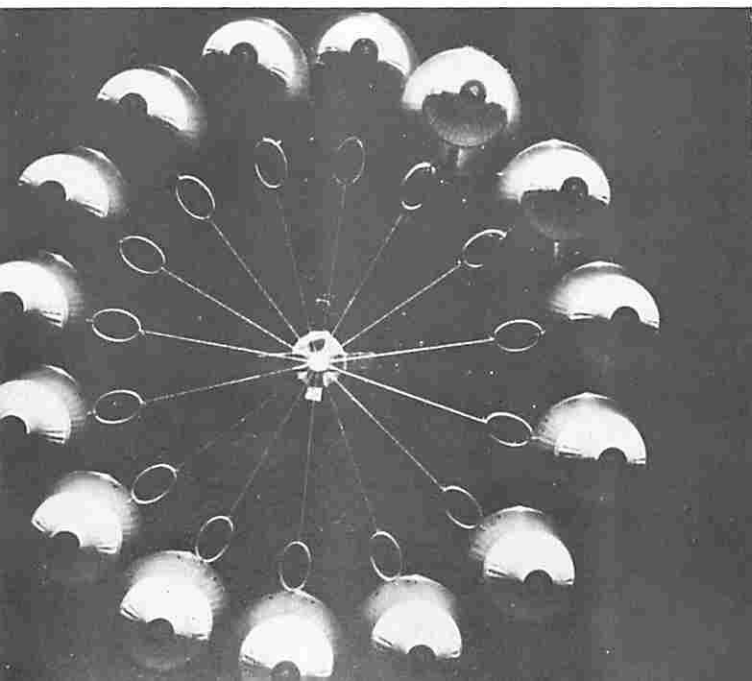



Smoke streams in a wind tunnel can be used to show turbulence patterns. The smoke is produced by the coking of grain straw and is introduced just upstream of antiturbulence screening. It flows with the air stream over and around the model at speeds ranging from 15 to 175 ft/sec. Photographs are taken through a transparent section in the side of the wind tunnel. Photograph above shows a propeller rotating at 4080 rpm with blade pitch set for best rate of climb and air speed about 45 ft/sec. Photograph below is of a spinning baseball, showing Magnus Effect, which causes its path to be curved. Courtesy of Professor F. N. M. Brown, University of Notre Dame.

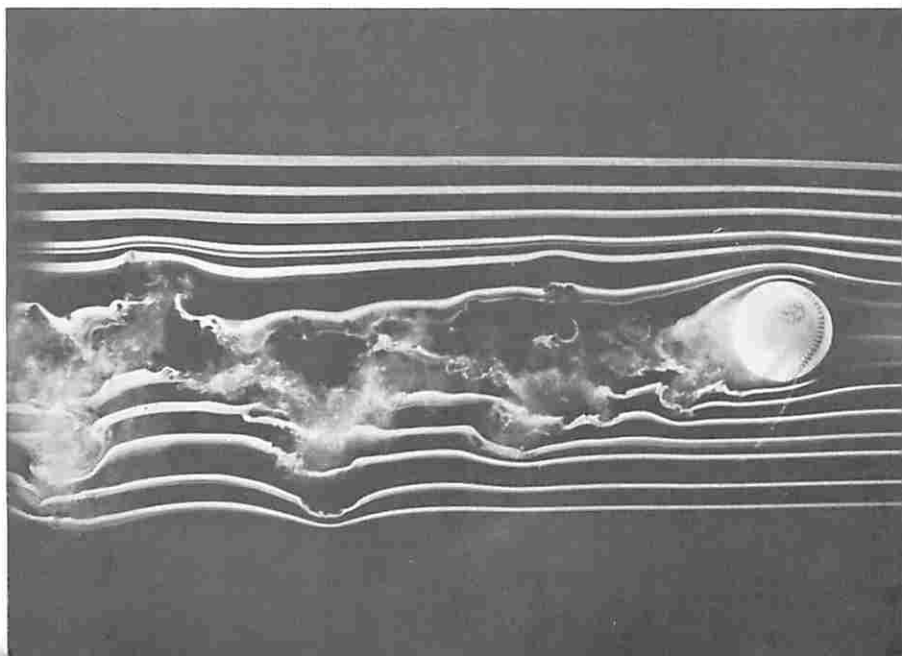

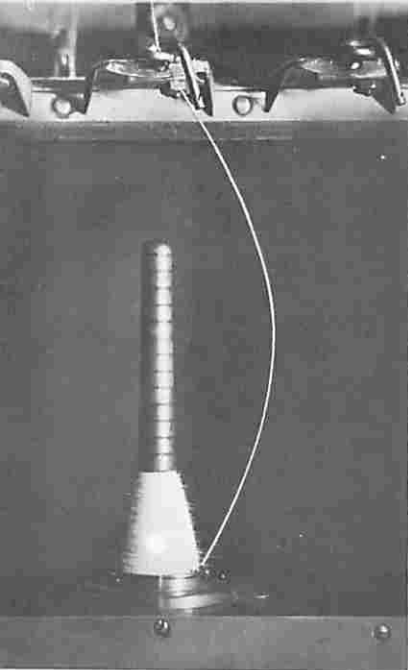

Spindle on a textile spinning frame at approximately 8000 rpm showing 'ballooning' of filament. The ring traveler can be seen at the lower right of the spindle just where the filament leaves the spindle.

Close-up, single-flash photographs of a textile ring traveler showing its angles of orientation. The left photograph shows the side view of the traveler and the right photograph the top view. Rotation speed of associated spindle was 10,000 rpm, and linear speed of traveler around the 2 $\frac{3}{4}$ -inch-diameter ring was 120 ft/sec. Type 1536-A Photoelectric Pickoff operated directly from the  $\frac{3}{16}$ " x  $\frac{1}{16}$ " traveler passing by. Traveler movement was 0.0005 inch during 3- $\mu$ sec flash from Strobotac. A 35-mm camera with 140-mm lens set for f/5.6 aperture was used. Courtesy of *Whitin Machine Works*.

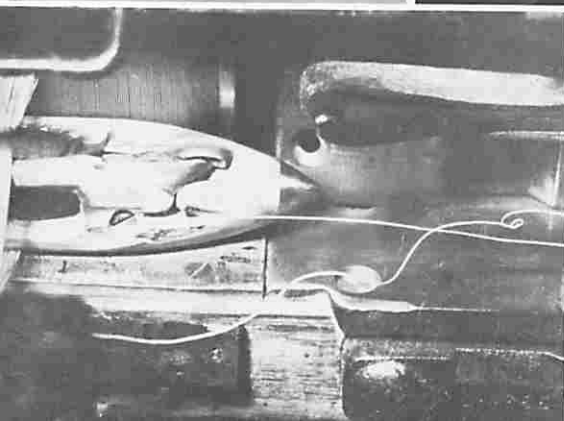
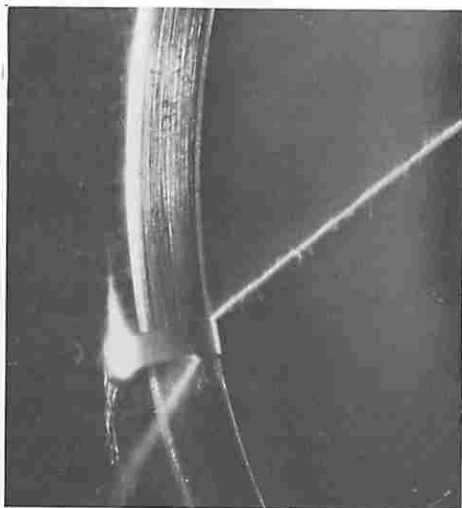

Shuttle in a textile loom just starting on its flight across the loom (traveling toward the left). Behavior of the thread can be clearly seen.

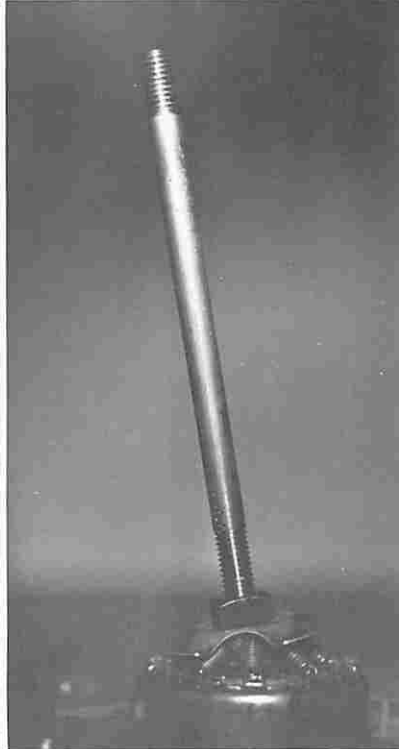
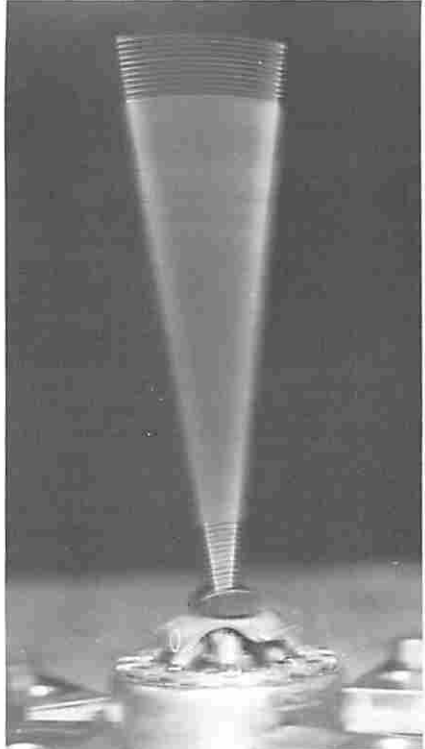

Rod mounted on spring shock mount vibrating on vibration table. Photograph at left under steady light shows amplitude of vibration. Photograph at right was taken with a single Strobotac flash.



Photograph of label-inspection process with label strip moving at 1000 ft/min. Courtesy of Wyeth Laboratories, Inc.



Combustion study of twin, oscillating gas flames using schlieren technique and stroboscopic light. Reflector of Strobotac was removed so that the flash lamp arc would approximate a point source of light. The parallel light rays produced by the schlieren technique refract differently as they pass through different regions of the flame having different density gradients, thus producing light and dark areas in the photograph. Rate of flame pulsation was twelve cycles per second; rate of stroboscopic flashing was 200 per second. The succession of single images shown in the photograph at left was taken with a streak camera at constant film speed. *Courtesy of Mr. Jon Kelly, M.I.T. Engine Laboratory.*

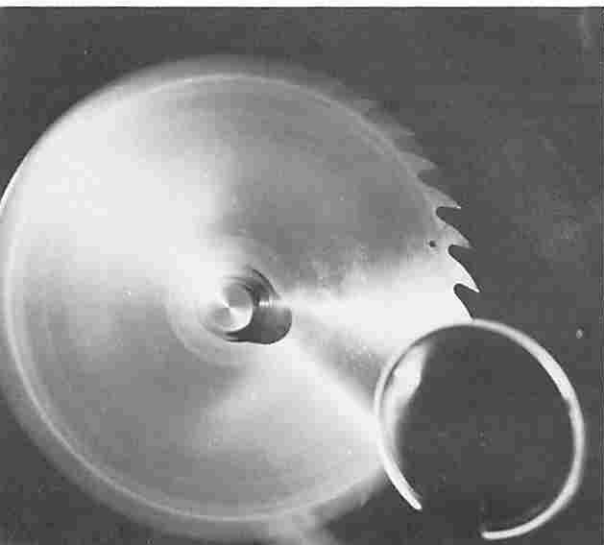

An 8-inch circular-saw blade rotating at 3450 rpm. Left side of blade appears blurred due to exposure under steady light directed only at that side, while right side appears stationary, with minute surface scratches clearly defined, under the 0.8-microsecond flash of the Strobotac.



Multiple-flash, stroboscopic photography used to track down the specific sources of noise in a textile loom for the purpose of noise reduction. Photograph above shows the setup with Strobotac, camera, end of loom where shuttle flight terminates, and microphone to pick up noise. Other equipment, not shown, includes a dual-beam cathode-ray oscillograph, a photoelectric cell, two pulse generators, and an oscillator. The photoelectric cell detects the approach of the shuttle and triggers the oscillograph sweep and the first pulse generator, which in turn triggers the second pulse generator after a delay long enough to allow the shuttle nearly to reach its deceleration point. The second pulse generator acts as a "gate" to allow the oscillator to trigger a burst of about 17 flashes from the Strobotac at a rate of 500 flashes per second. Photographs are taken in a dark room, with the camera shutter controlled manually.

Photograph below shows shuttle with white flag to mark position. At lower left is a multiple-flash stroboscopic photograph showing the shuttle's white flag as the shuttle decelerates. At lower right is a photograph of the oscillograph screen showing, on the upper trace, the timing of the light flashes in relation to the noise level detected by the microphone and shown on the lower trace.

Analysis of these photographs allows a definite correlation to be made between deceleration and instantaneous noise level, as a result of which the noise-control engineer can learn where effort to reduce noise can most effectively be applied. Courtesy of Mr. Allen L. Cudworth, Liberty Mutual Insurance Company.

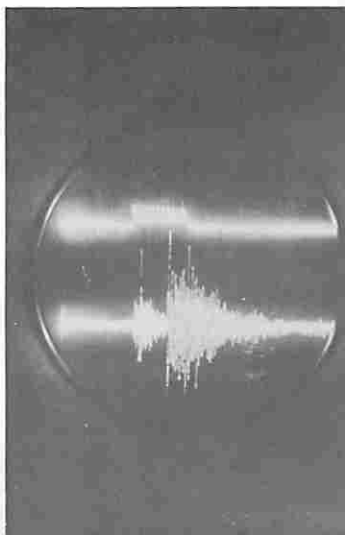
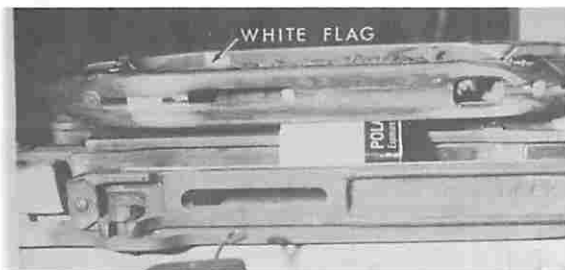

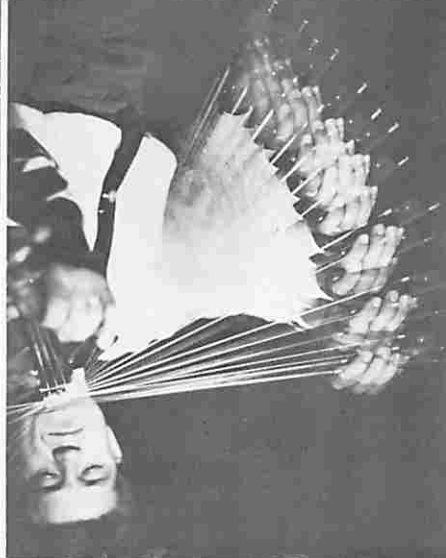
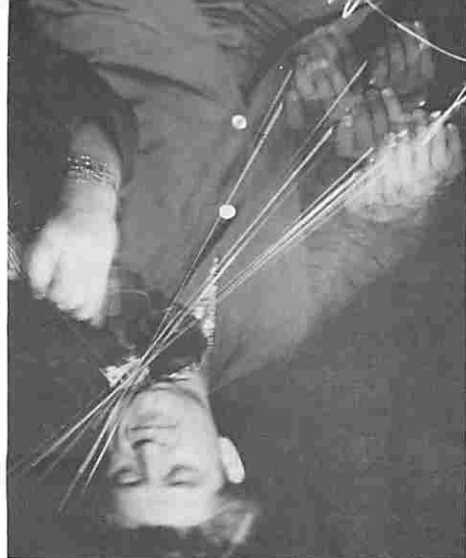

Multiple-flash stroboscopic photographs are an aid in teaching violin technique. The frozen images help to analyze and correct posture, hand attitude, and motor skills such as bowing and fingering. To produce the photograph at the right, a neon bulb was attached to the bow to show a continuous path as a supplement to the multiple images.

Courtesy of Dr. Louis C. Trzcinski, University of Nebraska.

Rapidly moving bubbles of human blood (plasma and red cells) and oxygen in an experimental apparatus for studying improved methods of blood oxygenation by heart-lung machines during open-heart surgery. Photographs such as this allow determination of the bubble sizes, figurations, and number per square inch. Courtesy of Dr. C. Lloyd Claff, Director of Research, Single Cell Research Foundation, Inc., Randolph, Massachusetts.

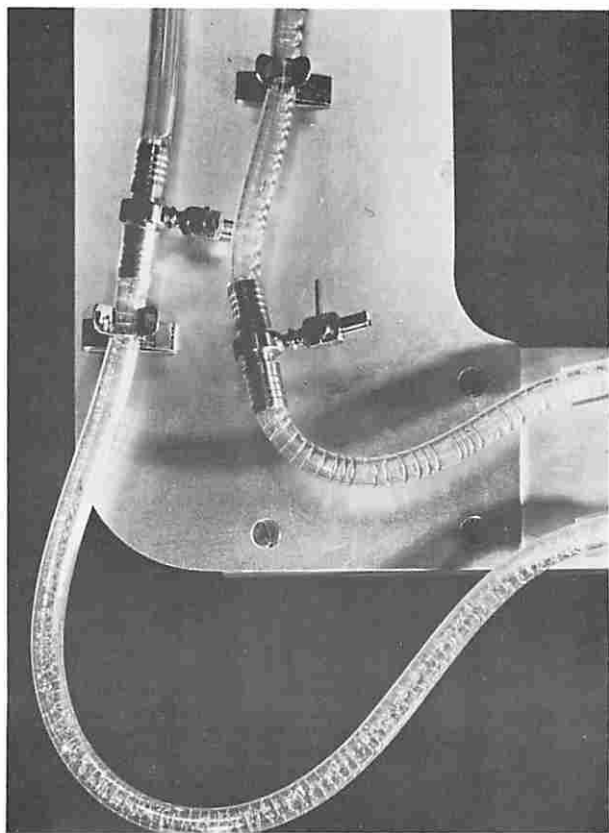

Study of effect of strong transverse electric fields on falling liquid drops, as might occur in rain clouds. Multiple-flash photographs were taken at a Strobotac flashing rate of 700 flashes per minute while a drop of milk fell between two metal plates charged to create a field strength of 10 kv/cm. The drop stretches out as it falls until a discharging spark occurs, after which surface tension pulls it together again. Royal X 4" x 5" sheet film developed in D76. Courtesy of David C. Eldridge, Edward M. Skinner, and James Tsepas, Andover High School, Massachusetts.

Shadowgraphs of a bullet passing through a soap bubble filled with Freon-12. A Strobotac was used as a point source by removal of the reflector and orientation of the flash lamp so that the arc of the flash was in line with the direction of the subject and about three yards distant. Instead of a camera, a Polaroid 4" x 5" film back with Polaroid 3000 film was placed 3 1/2" from the bubble on the opposite side from the light source. The flash was triggered by means of a microphone. Photograph below shows bullet entering bubble and the intensification of the shock wave in the Freon-12. Photograph at bottom shows another bullet leaving a bubble, with strong turbulence in its wake.

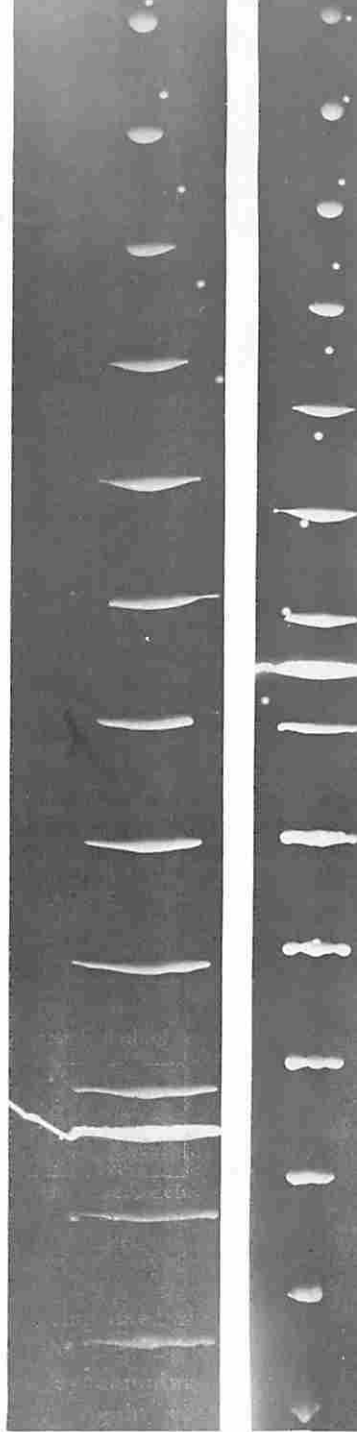
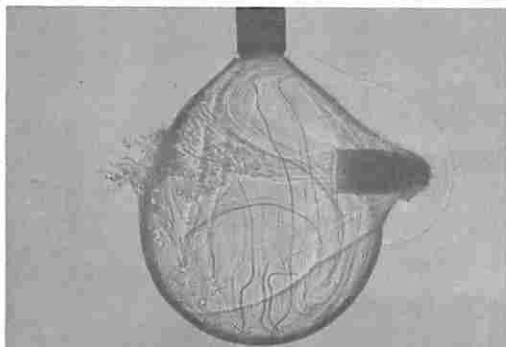
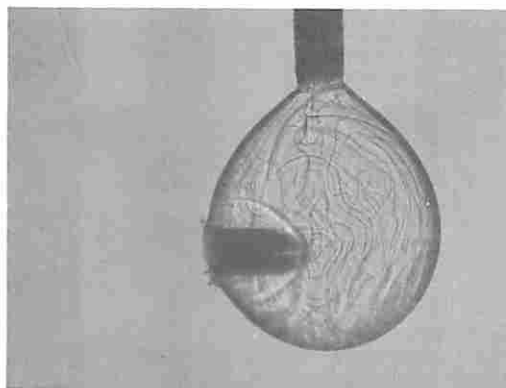



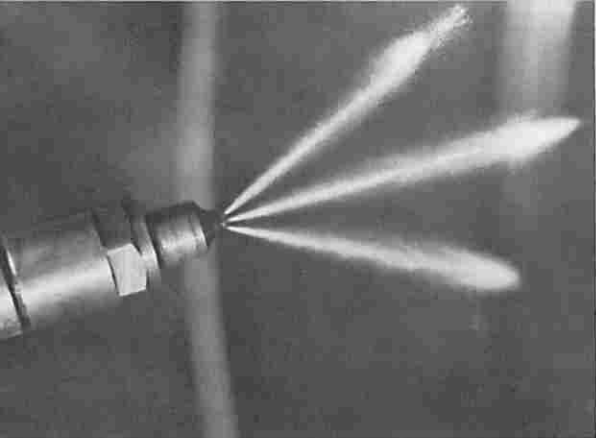

Spray pattern of diesel fuel-injection nozzle. With suitable photographic technique and large-scale photographs, such pictures can be used in estimating droplet size and size distribution.

How to take a "high-speed movie" with a still camera. The sequence of photographs shows a cam and misbehaving follower. The cam is rotating at 3000 rpm. The photos were taken with a Strobotac, Flash-Delay Unit, and Photoelectric Pickoff. Positioning of the cam was accomplished with the Flash Delay by advancing the time delay control to a new position for each photo. Exposure was at  $f/22$  using Polaroid Type 57 (3000 ASA) sheet film.

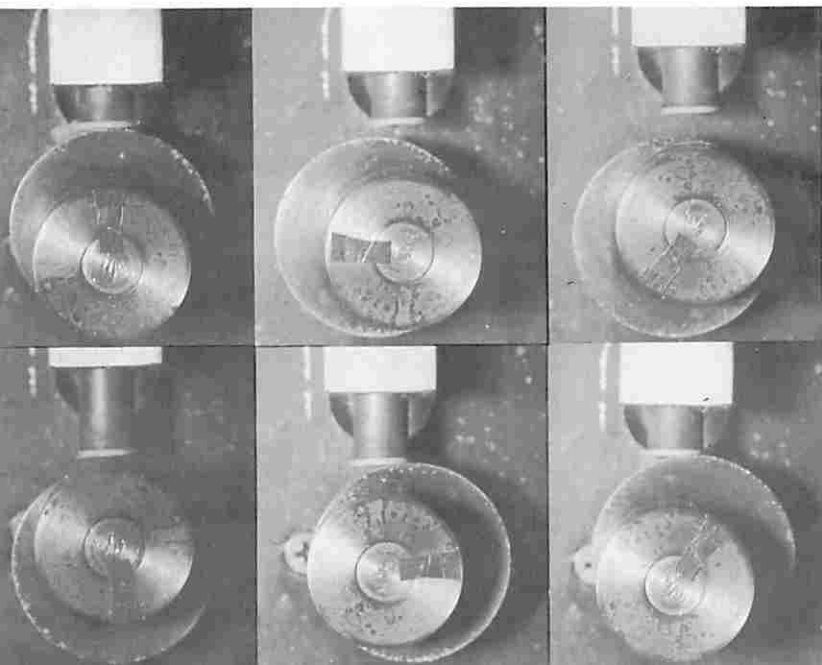

A double exposure showing the before and after of a shattering paper disc. The disc, about 8 inches in diameter, is mounted on the shaft of a motor. Motor speed is increased until, at about 13,000 rpm, the disc shatters with almost explosive force. The noise is picked up by a microphone, amplified and used to trigger a single high-intensity flash from a Strobotac. The photo was taken in a darkened room to eliminate synchronization problems. Any camera having a "bulb" or "time" shutter position can be used. Exposure data: Kodak Royal Pan (ASA400); f/16; light source, a 1538 Strobotac and 1538-P4 Energy Storage Capacitor.



The glide and landing of a flying squirrel captured on film with the aid of a Strobotac and Strobolume. Courtesy of C.G. Hampson, Associate Professor of Biological Sciences, University of Alberta, Edmonton, Canada.



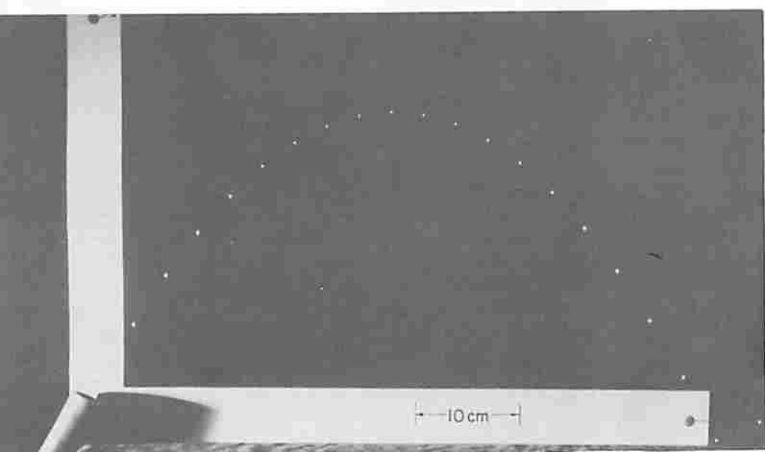
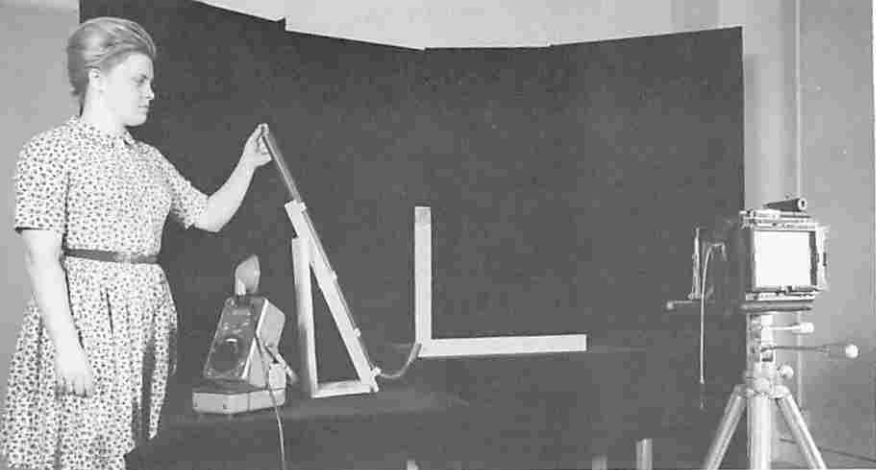

Multiple-flash of golf ball just after impact taken with five 1531 Strobotac® electronic stroboscopes, each firing once. Spacing between each flash is 1.5 milliseconds (equivalent flashing rate, 666 flashes per second). Triggering was initiated by a photoelectric pickoff directed at the tee. Exposure data: Kodak Royal Pan (ASA400); f/16; lamp to subject distance for each flash was 2 feet.



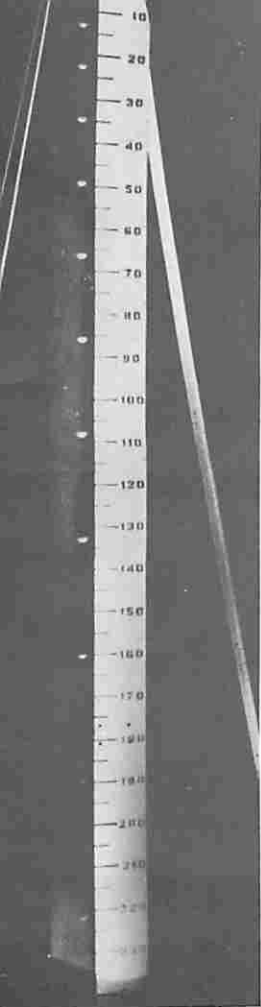

Multiple-flash photographs taken in the classroom help teach the concept of acceleration. With a Polaroid camera and Type 46L film, a positive transparency is available for projection (life size) a few minutes after the students see the original action. The photos show a classroom setup with ball about to be dropped and the resulting photographic record of the travel of the ball. The ball is photographed at fixed time intervals. The widening gaps between the images proves the rule of constant acceleration caused by the force of gravity even to the most skeptical student.

A similar arrangement can be used to analyze the motion of a projectile (see opposite page). In this experiment, a steel ball is launched by dropping it into a steel tube. The resulting trajectory is photographed by multiple-flash techniques. If a scale is included in the setup, then the horizontal and vertical components of velocity can be determined directly from the photograph.

A pulsating, solenoid-actuated water pump and its water stream shown both with and without stroboscopic lighting. The pump rate is 60 impulses per second. Exposure data: one 1532 Strobolume used to back-light the scene; camera setting  $f/22$  using Kodak Tri-X film; camera shutter operated manually; single flash from Strobolume triggered from X shutter contacts.

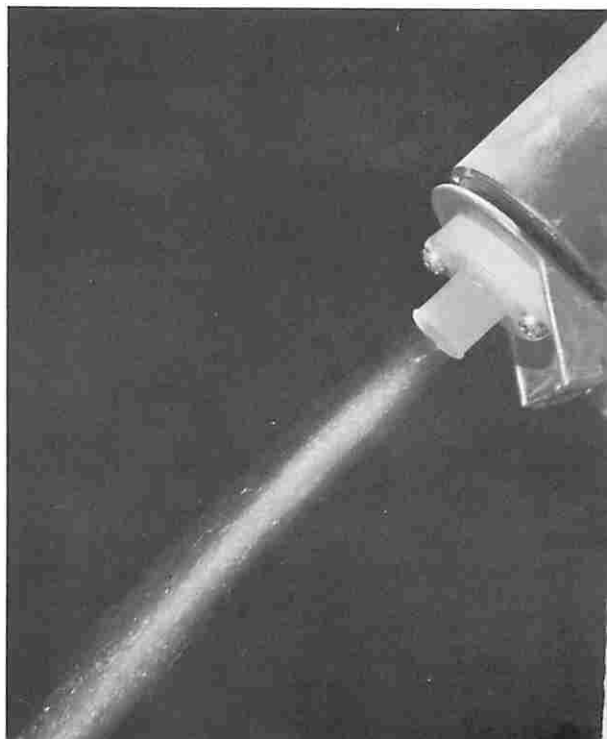
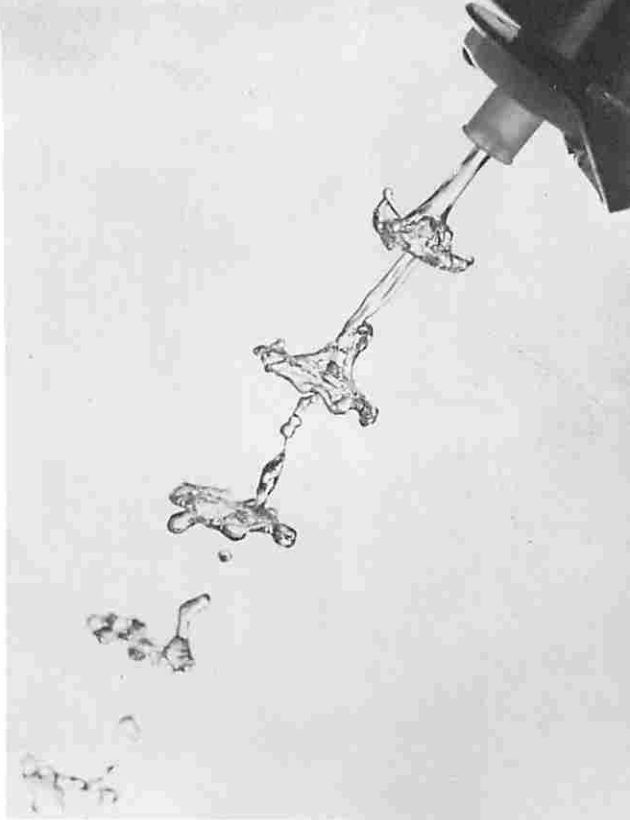

## BIBLIOGRAPHY

The following sources constitute a reasonably representative sample of available reference materials dealing with subjects pertinent to high-speed photography. They do not represent an exhaustive listing, but most contain bibliographies of their own which, taken together, provide extensive coverage of the field.

Aspden, Ralph L., Electronic Flash Photography, The Macmillan Company: New York, New York, 1959.

(Contains design and application data, an equipment summary, and descriptions of several specialized techniques. Probably most useful to the scientist or photo-instrumentation engineer.)

Castle, John, "The Photographic Response of Several High-Speed Emulsions at Very Short Exposure Times," Photographic Engineering, Vol 5, No. 3, 1954, 189-194.

Castle, J. and J. H. Webb, "Results of Very Short-Duration Exposures for Several Fast Photographic Emulsions," Photographic Engineering, Vol 4, No. 2, 1953, 51-59.

Chesterman, W. Deryck, The Photographic Study of Rapid Events, Clarendon Press: Oxford, England, 1951.

Courtney-Pratt, J. S., "A Review of the Methods of High-Speed Photography," Reports on Progress in Physics, Vol 20, 1957, 379-432.

Eastman Kodak Company, Bibliography of High-Speed Photography; Rochester, New York.

Eastman Kodak Company, KODAK Reference Handbook: Rochester, New York.

(Several loose-leaf volumes contain individual booklets covering practically every phase of photography. An invaluable reference.)

Eastman Kodak Company, Schlieren Photography: Rochester, New York, 1960.

(Explains the basic schlieren method and describes several systems for taking schlieren photographs. An excellent primer on the subject.)

Edgerton, Harold E., "Shock-Wave Photography of Large Subjects in Daylight," Review of Scientific Instruments, Vol 29, No. 2, February, 1958, 121.

(Describes Edgerton's method for making shadow photographs of shock-wave patterns using a reflective Scotchlite backdrop.)

Edgerton, Harold E. and James R. Killian, Jr., Flash! Seeing the Unseen By Ultra High-Speed Photography, 2nd edition, Charles T. Branford Company: Newton, Massachusetts, 1954.

(Recommended for beginners and experts alike. A true classic from both scientific and artistic standpoints, this book contains the finest collection of original high-speed photographs ever published. It stimulates a wealth of ideas.)

General Radio Company, Operating Instruction Manual, Type 1531-AB Strobotac® electronic stroboscope, Form 1531-0100-1.

General Radio Company, Operating Instruction Manual, Type 1532-D Strobolume, Form 1532-0100.

Henney and Dudley (ed.), Handbook of Photography, Whittlesey House: New York, 1939.

(A standard reference for the professional photographer.)

Hyzer, William G., Engineering and Scientific High-Speed Photography, The Macmillan Company: New York, New York, 1962.

(Contains an excellent chapter on Techniques in High-Speed Photography and offers a thorough, comprehensive summary of modern equipment and methods.)

Jones, George A., High-Speed Photography, Its Principles and Applications, Chapman & Hall, Ltd.: London, England, 1952.

Also published by John Wiley & Sons, Inc.: New York, New York, 1952.

(An exhaustive presentation of equipment and techniques developed to date, along with some applications data.)

Kivenson, Gilbert, Industrial Stroboscopy, Hayden Book Company; New York, New York, 1965.

Laue, Eric G., "A Strobe-Control System For Motion-Picture Cameras," Jet Propulsion Laboratory, California Institute of Technology: Pasadena, California, Memorandum No. 20-95, 1954.

Mees, C. E. Kenneth, The Theory of the Photographic Process, revised edition, The Macmillan Company: New York, New York, 1954.

(A highly technical reference most useful to the photochemist or experienced film processor.)

Neblette, C. B., Photography, Its Materials and Processes, 2nd edition,

D. Van Nostrand Company, Inc.: Princeton, New Jersey, 1952.  
(A straightforward, easily understood textbook covering practically all phases of photography.)

Palme, Arthur, Speedlights, Construction and Use, American Photographic Publishing Company: Boston, Massachusetts, 1946.  
(Directed at the photographer, this book contains a chapter describing in detail several simple methods for synchronizing an electronic flash unit with a camera shutter. Also includes a section with several interesting electronic-flash photographs.)

Photo Methods for Industry, Gellert-Wolfman Publishing Corp., 33 West 60th Street, New York, New York. (A monthly magazine with frequent columns on high-speed photo techniques.)

Proceedings of the International Congress on High-Speed Photography.  
Seven congresses have been held to date. Each proceedings has usually been prepared by a different editor and publisher:

The two most recent editions are:

Proceedings of the Sixth International Congress on High-Speed Photography, edited by J. G. A. DeGraaf and P. Regelar, published by H. D. Tjeenk, Willink, and Zoon N.V., Haarlem, Holland.

Proceedings of the Seventh International Congress on High-Speed Photography, published by Verlag Dr. Othmar Helwich, Darmstadt, Germany.

Rutowski, J., Stroboscopes for Industry and Research, Pergamon Press; London, England, first English edition, 1966.

Society of Motion Picture and Television Engineers, High-Speed Photography, bound reprints from Journal of the SMPTE: New York, New York, 1952-1957.

Society of Motion Picture and Television Engineers, Instrumentation and High-Speed Photography, Vol 1, Series II: New York, 1960.

Tupholme, C. H., Photography In Engineering, Faber and Hyperion Ltd.: London, England, 1945.

Waddell, J. H. and J. W. Waddell, Photographic Motion Analysis, Industrial Laboratories Publishing Co.: Chicago, Illinois, 1955.

#### **NEW TWO-PART ARTICLE SUMMARIZES LATEST APPLICATIONS**

Miller, Charles E., "Using Stroboscopy for Stop-Action Study of High-Speed Events," *Machine Design*, Apr. 30, 1970, pp 220-228, May 14, 1970, pp 188-194. Copies available free from General Radio—ask for reprint A-146 (contains both parts).



# INDEX

- Acceleration 5, 79
- Accuracy 18
- Acoustic Triggering 47, 50, 73, 77
- Afterglow 2, 25, 29
- Airplane Model 59, 60
- Air Flow 69
- Allowable Delay 39, 48, 57
- Ambient Light 35
- Angular Velocity and Displacement 4
- Apparent Source 16, 19, 21, 27
- Aperture Correction 32
- Arc Dimensions 35
- Auxiliary Capacitor 21, 22
- Ballistics 2, 12, 36, 42, 75
- Battery Operation 21
- Beam Angle 16, 19, 21, 23
  - coverage 27
- Beam-Candle Power 11
- Bellows Extension Correction 32
- Blur, Calculation 1, 2
  - due to afterglow 2, 25, 29
  - due to cont. light 37
- Brightness 11
- Bullet Photography 2, 12, 36, 42, 75
- Cable Interconnections 16, 20, 23, 48
- Calibration, Time 54
- Cam Photography 76
- Cameras, Strobe Use With
  - high-speed 8, 61
  - movie 58
  - Polaroid 21
  - still 25
- Capacitor, Auxiliary 21, 22
- Cavitation Photography 66
- Close Up Correction 32
- Color Film
  - color temperature of flash 28
- Combustion Photography 72
- Contact Bounce 20, 38, 42, 64
- Contactors 20, 42, 43
- Contrast 29, 32, 45
- Cyclic Motion 4
- Daylight, Spectrum 28
- Decay Time, See Afterglow
- Delay
  - acoustic 47, 53
  - allowable 39, 48, 57
  - generator 48
  - internal 52
  - need for 39
  - shutter contact 51
- Depth-of-Field 29
- Diesel Engine Fuel Injector 76
- Discharge, Lamp
  - arc size 35
  - repetitive, guide number correction 31
  - xenon 25, 28
- Displacement, Angular 4
- Droplet Formation 76
- Droplets 3, 75, 80
- Duration, Flash 11, 25
- Electrical Triggering 45
- Example
  - photo procedure 55
- Exposure Guide 30
  - correction for frequency 31
  - continuous light-to-flash ratio 37, 57
- Extension Lamp 16, 21
- False Twist Spindle 55, 61
- Film Characteristics 28
  - selection 29
- Flashbulbs 1
- Flash
  - burst 25
  - duration 11, 25
  - intensity 11, 25
  - repetitive 31, 54
  - synchronization 41
- Flash Delay 48
- Fluid Flow 74, 80
- Focal Plane Shutter 40, 63
- Fracture 7
- Framing Rate 59, 62
- Frequency, Correction for 31
- Fringe Patterns 7
- Guide Numbers 30, 92
  - corrections 31
- Gradient Photography 35

- Harmonic Operation 59
- High-Speed Movie Camera 61
- Intensity, Flash 12
- Jitter 60
- K Factor 32
- Lamp
  - xenon 25, 28, 35
- Lighting Techniques 32
- Light Ratio 57
- Liquid Photography 3, 66, 74, 75, 80
- Modeling (illumination) 17
- Motion Picture Photography 58
- Moving Film 8, 58
- Multiple Exposure 2, 12, 31, 37, 53, 54, 58, 67, 68, 73, 74, 75, 77, 78, 79
- Multiple Lamps 17, 54
- Offset Frequency 15, 59
- Open Flash 35, 40
- Optical Triggering 44, 45
- Oscillator 18, 21, 22, 62
- Phase Control 43
- Photoelasticity 7
- Photoelectric Pickoff 4
- Physics Experiments 67, 68, 75, 79
- Polaroid Materials 29
- Point Source 34, 36
- Processing Film 31
- Proximity Pickup 46
- Quick Check of System Performance 29, 56
- Reed Relay 64
- Reflector 25
- Remote Lamp 21
- Repetitive Flashing 31
- Repetitive Motion 17
- Ring Traveler 62, 70
- Schlieren 72
- Scotchlite 33, 36
- Swing Machine 13, 15
- Shadow Photography 34, 36, 75
- Shock Waves 36
- Side Lighting 33
- Single Flash 49
- Shutters, Camera
  - between-the-lens 38
  - focal plane 40, 60
  - prism 61
  - sync 38, 51, 60
- Slave Unit - See Stroboslave
- Slow-Motion Image 59
- Spot Diameters 27
- Stress Analysis 7
- Strobe Characteristics 9
  - comparison 11
- Strobolume 23
- Stroboslave (Type 1539) 16
- Strobotac
  - Type 1531 18
  - Type 1538 21
- Synchronization 13, 41, 51
  - movie 59, 61
- Synchronizers
  - contact 42, 63
  - electrical 45
  - installation, movie camera 63
  - magnetic 46, 62, 63
  - microphone 47
  - photoelectric 44, 62, 63
  - test 38, 51
- Tape, Reflective 45
- Test Exposures 29, 56
- Time Delay 2, 52
  - generator (Type 1531-P2) 48
- Timing (sync) 13
- Tone-Burst Generator 54
- Transient Event 75, 77
- Triggering 16, 20, 22, 24, 41
  - acoustic 47, 50
  - circuits 20, 52
  - polarity 29
- Turbulence 66, 69
- Ultraviolet 28
- Uneven Exposure 40
- Unsynchronized Operation 62
- Velocity Measurement of
  - angular 4
  - linear
- Watts-Seconds 11
- Xenon 1, 25, 28
- X Synchronization 38, 39, 51

## Type 1531-AB STROBOTAC® ELECTRONIC STROBOSCOPE



- "stops" rapid motion visually
- 1% accurate speed measurements to 250,000 rpm
- intense light source for high-speed photography
- simple to use — easy to handle

The Strobotac® electronic stroboscope is a small portable flashing-light source used to measure the speed of fast-moving devices or to produce the optical effect of stopping or slowing down high-speed motion for observation. A few of this instrument's many uses are:

- Observation and speed measurement of gears, cams, linkages, shuttles, spindles, motor rotors, and any other elements having repetitive motion.
- Observation of vibrating members, fuel-nozzle spray patterns, and vibrations of components under test in wind tunnels.
- High-speed photography of repetitive or non-repetitive motion.

The flashing-rate range of 110 to 25,000 flashes per minute is divided into three direct-reading ranges; to

avoid reading errors, only the particular range in use is illuminated. The flash lamp can be triggered externally to "stop" motion for photography. The combination of the 1531-P2 Flash Delay and the 1536-A Photoelectric Pickoff can be used as an external triggering source, which also provides an adjustable delay of the stroboscope flash with respect to the triggering pulse from the photoelectric pickoff.

A built-in calibration system uses the power-line frequency for quick, easy check and readjustment of the flashing-rate calibration.

The strobotron flash lamp and reflector assembly pivots in a plane perpendicular to the panel and swivels 360 degrees on its own axis. The case is equipped with a 1/4 x 20 socket for mounting the instrument on a tripod.

This instrument is listed as approved by CSA Testing Laboratories.

### specifications

**Flashing-Rate Range:** 110 to 25,000 flashes per minute in three direct-reading ranges: 110 to 690, 670 to 4170, and 4000 to 25,000. Speeds up to 250,000 rpm can be measured.

**Accuracy:** ±1% of dial reading after calibration on middle range.

**Calibration:** Two panel adjustments permit calibration against power-line frequency.

**Flash Duration:** Approx 0.8, 1.2, and 3 μs for high-, medium-, and low-speed ranges, respectively, measured at 1/2 peak intensity.

**Peak Light Intensity:** Typical on high-, medium-, and low-speed ranges, respectively, 0.5, 3.5, and 11 million beam candelas (6 × 10<sup>6</sup>, 3.5 × 10<sup>6</sup>, and 11 × 10<sup>6</sup> lux at 1 meter distance at the center of the beam); for single flash, 18 million beam candelas (18 × 10<sup>6</sup> lux at 1 meter distance at the center of the beam). Photographic guide number is 30 for ASA 400 film speed and high-intensity flash.

**Reflector Beam Angle:** 10° at half-intensity points.

**Output Trigger:** 500- to 1000-V negative pulse available at panel jack.

**External Triggering:** The flash can be triggered by the opening of a mechanical contactor or by a 6-V pk-pk signal (2-V rms sine-wave signal down to 5 Hz).

**Power Required:** 105 to 125 or 210 to 250 V, 50 to 400 Hz, 35 W.

**Accessories Supplied:** Adjustable neck strap, plug to fit input and output jacks.

**Accessories Available:** 1531-P2 Flash Delay and 1536-A Photoelectric Pickoff, 1539-A Strobostave with 1531-P4 Trigger Cable.

**Mounting:** Flip-Tilt Case.

**Dimensions (width x height x depth):** 10 1/2 x 6 1/2 x 6 1/2 in. (270 x 170 x 160 mm).

**Weight:** Net, 7 1/4 lb (3.3 kg); shipping, 9 lb (4.1 kg).

Catalog Number	Description
	<b>1531-AB Strobotac® electronic stroboscope</b>
1531-9430	115-V ac Model
1531-9440	230-V ac Model
1538-9601	<b>1538-P1 Strobotron Replacement Flash Lamp</b>

## Type 1539-A STROBOSLAVE®

### STROBOSCOPIC LIGHT SOURCE

- low cost, compact
- removable lamp on 5-foot cable
- high light output — same as Type 1531
- choice of trigger sources



Tripod socket is provided on Stroboslave case.



The Stroboslave is a stroboscopic light source that satisfies the basic requirements for motion studies and high-speed photography. It is suitable for all stroboscope applications except speed measurement. More than one Stroboslave can be used where there is a need for multiple light sources. When the reflector is removed from the end of the extension cord, the strobotron lamp assembly can be inserted through a hole as small as one

inch, making it possible to observe objects in otherwise inaccessible areas. Locking connectors at the lamp's head permit extension-cord lengths up to 50 feet.

The Stroboslave has no internal oscillator for setting the flashing rate. It will operate directly from a switch closure, a 1537-A Photoelectric Pickoff, or a 1531-P2 Flash Delay with a 1536-A Photoelectric Pickoff. A Stroboslave with the latter two accessories is available as the 1539-Z Motion-Analysis and Photography Set for high-speed photography with conventional cameras and for visual analysis where speed need not be measured. In addition, the Stroboslave will operate from the output of the 1538-A Strobotac® electronic stroboscope directly, from the output of a 1531 Strobotac through a 1531-P4 Trigger Cable, or from any source of a positive electrical pulse of at least 2 volts peak.

The Stroboslave produces the same light output as the 1531 Strobotac and operates over the same three basic ranges from 0 to 25,000 flashes per minute. The strobotron lamp and reflector are connected to the unit by a five-foot flexible cable so that the light can be positioned close to the subject to be observed.

— See *GR Experimenter* for April 1966.

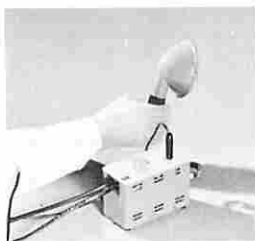

Lamp, at end of five-foot cable, can be held in hand as shown here or attached to case as shown above.

### specifications

**Flashing-Rate Ranges:** 0 to 700, 0 to 4200, 0 to 25,000 flashes per min on high-, medium-, and low-intensity ranges, respectively.

**Flash Duration:** Approx 0.8, 1.2, and 3  $\mu$ s, measured at 1/2 peak intensity, for the low-, medium-, and high-intensity ranges, respectively.

**Peak Light Intensity:** Typically 0.6, 3.5, and 11 million beam candelas (0.6, 3.5 and  $11 \times 10^6$  lux measured at 1-m distance at the beam center), for low-, medium-, and high-intensity ranges, respectively. For single flash, 18 million beam candelas at 1 meter. Photographic guide number is 30 for high-intensity range and ASA 400 film speed.

**Reflector Beam Angle:** 10° at half-intensity points.

**External Triggering:** Either a switch closure across the input jack terminals or a 2-V (peak) positive pulse.

**Power Required:** 100 to 125 or 195 to 250 V, 50 to 400 Hz, 16 W (max) at 115 V.

**Accessories Supplied:** Phone plug for input, mounting bracket.

**Accessories Available:** 1531-P2 Flash Delay with a 1536-A Photo-

electric Pickoff (available with a 1539-A as the 1539-Z Motion-Analysis and Photography Set), 1537-A Photoelectric Pickoff.

**Mounting:** Metal case with detachable lamp housing.

**Dimensions (width x height x depth):** 2½ x 8¾ x 4¼ in. (64 x 215 x 105 mm).

**Weight:** Net, 2¼ lb (1.3 kg); shipping, 8 lb (3.7 kg).

Catalog Number	Description
1539-9701	1539-A Stroboslave® stroboscopic light source
1531-9604	1531-P4 Trigger Cable (for use with 1531 Strobotac)
1538-9601	1538-P1 Replacement Strobotron flash lamp
1539-9900	1539-Z Motion-Analysis and Photography set for 115-V operation
1539-9901	for 230-V operation

## Type 1538-A STROBOTAC® electronic stroboscope

- flashing rates up to 150,000 per minute
- speed measurements to 1 million rpm
- battery or power-line operation
- remote flash lamp on extension cable
- extra-high-intensity single flash for photography

1538-P3

1538-P4

1538-A  
STROBOTAC AND  
ACCESSORIES

1538-P2

1538-A

The 1538-A Strobotac is able to satisfy a broader range of applications than the 1531-A. In addition to its higher maximum flashing rate, it has several accessories available for extending its performance and convenience. It can be operated from a power line, or, if there is no power outlet nearby, from the rechargeable battery pack. The accessory extension lamp is useful in illuminating hard-to-reach areas.

This stroboscope is ideally suited for photographic applications requiring a high light intensity. With the 1538-P4 High-Intensity-Flash Capacitor, it produces 8-microsecond flashes of 44 million beam candleas at one-meter distance. This results in a guide number of about 250 when a film rated at ASA 3000 is used.

The 1538-A circuits are all transistorized. This not only makes possible battery operation but also ensures greater stability of the flashing rate.

The flash can be triggered externally by a simple con-

tact closure across the input terminals, by a positive pulse, or by a sine wave. With a photoelectric pickoff, the flash can be triggered by pulses that are synchronized with a mechanical motion. The 1537-A Photoelectric Pickoff connects directly to the 1538-A and contains a light-activated switch but no light source. The 1536-A pickoff contains a photocell and light source, for which power is supplied by the 1531-P2 Flash Delay. With this combination, an adjustable delay is introduced between the time a selected point on a moving object passes the pickoff and the time at which the Strobotac flashes. Three-way synchronization of the camera shutter, the mechanical motion, and the Strobotac flash is a very useful feature of this combination. Both the Strobotac and the 1538-P4 High-Intensity-Flash Capacitor are equipped with sockets for attaching the two together and for tripod mounting.

— See GR Experimenter for April 1966.

### specifications

**Flashing-Rate Range:** 110 to 150,000 flashes per minute in four direct-reading ranges: 110 to 690, 670 to 4170, 4000 to 25,000, and 24,000 to 150,000 rpm. Speeds to 1 million rpm can be measured.

**Accuracy:**  $\pm 1\%$  on all ranges after calibration on 670- to 4170-rpm range against 50- or 60-Hz line frequency.

**Flash Duration:** Approx 0.5, 0.8, 1.2, and 3  $\mu$ s for high-to-low speed ranges, respectively, measured at  $1/2$  peak intensity; 8  $\mu$ s for single flashes with 1538-P4 High-Intensity-Flash Capacitor.

**Peak Light Intensity:** Typically 0.16, 1, 5, and 15 million beam candleas (0.16, 1, 5, and 15  $\times 10^6$  lux measured at 1 meter distance at the beam center) for high-to-low speed ranges, respectively; 44 million beam candleas at 1 meter for single flash, with 1538-P4 High-Intensity-Flash Capacitor.

**Reflector Beam Angle:**  $10^\circ$  at half-intensity points.

**Output Trigger:** Greater than 6-V positive pulse behind 400  $\Omega$ .

**External Triggering:** Either a switch closure across the input jack terminals, a 1-V (peak) positive pulse, or a 0.35-V (rms) sine wave down to 100 Hz increasing to 3.5 V (rms) at 5 Hz.

**Power Required:** 100 to 125 or 195 to 250 V, 50 to 400 Hz, 15 W (max) or 20 to 30 V dc, 12 W (max).

**Accessories Supplied:** Adjustable neck strap, phone plug for input and output jacks, power cord.

**Accessories Available:** 1538-P2 Extension Lamp, 1538-P4 High-Intensity-Flash Capacitor (1538-P2 and -P4 cannot be used simultaneously), 1538-P3 Battery and Charger, 1531-P2 Flash Delay, 1536-A Photoelectric Pickoff (use with flash delay), 1537-A Photoelectric Pickoff, and 1539-A Stroboslave® stroboscopic light source. Mounting: Flip-Tilt Case.

**Dimensions** (width x height x depth): 10 1/2 x 6 1/2 x 6 1/2 in. (270 x 170 x 160 mm).

**Weight:** Net, 7 1/4 lb (3.3 kg); shipping, 10 lb (4.6 kg).

Catalog Number	Description
	<b>1538-A Strobotac® electronic stroboscope</b>
1538-9701	115-V ac Model
1538-9702	230-V ac Model
1538-9601	<b>1538-P1 Replacement Strobotron flash lamp</b>
1538-9602	<b>1538-P2 Extension Lamp</b>
1538-9603	<b>1538-P3 Battery and Charger</b>
1538-9604	<b>1538-P4 High-Intensity-Flash Capacitor</b>
1560-2101	<b>1560-P76 Patch Cord</b> , connects output of 1538 to input of another 1538 or 1531 Strobotac, a 1539 Stroboslave, or a 1531-P2 Flash Delay.

## Type 1540 STROBOLUME®

### ELECTRONIC STROBOSCOPE

- brilliant white light
- 0 to 25,000 flashes per minute
- wide-beam flood area for photographs



With the aid of a stroboscope you can examine the motion of machines, objects in flight or exploding, fluid spray patterns, and many other events as though they were motionless. With a calibrated stroboscope, you can measure the rate of repeating motion to a 1% accuracy up to ¼ million rpm.

With the new bright-light 1540 Strobolume, you can do all of the above under more difficult lighting conditions and even take color photographs of the strobe-stopped events. The 1540 is the first stroboscope to generate so much light, yet be fully versatile for general-purpose uses. Three control units are available; with the right one for the job, the 1540 can be flashed continuously or synchronized with the motion or camera for single flashes or bursts. Thus, it will "hold" a repeating motion in one chosen position, freeze a once-only event on film, or expose a motion to multiple-flash analysis.

Every flash, a pulse of white light lasting less than 15 microseconds, illuminates a 7 by 13-foot area at a 10-foot distance with enough light for still, movie, or, for electronic recording, TV pictures.

The flash can be triggered from a photoelectric pickoff, the opening or closing of a switch contact or camera shutter, or an electrical pulse or sine-wave signal. The flash can occur at the instant of the triggering event or be delayed by any desired time from 100 microseconds to 1 second to catch a subsequent event.

All three control units accept external signals for triggering the flash. In addition, the 1540-P4 Oscillator/Delay contains a circuit that will either oscillate to produce continuous flashing at rates from one-every-two-seconds to over 25,000 per minute or will delay external input trigger signals from 100 microseconds to 1 second. The Oscillator/Delay is well suited to photography; with it the flash of the 1540 can be synchronized with the motion and a camera, occurring only when the shutter is open and the moving object is in the desired position. The 1540-P1 Strobolume Oscillator provides accurate continuous flashing of the Strobolume for 1% speed measurements from

110 to 25,000 rpm. The 1540-P3 Strobolume Control Unit, simplest of the three control units, flashes the 1540 only in response to external signals.

#### DESCRIPTION

The working part of the 1540 Strobolume is the lamp head to which one of three control units attaches, either directly or by extension cable for remote operation. The combination is small, easily handled, and tripod mountable. It is connected to the larger power supply/carrying case by a twelve-foot cable.

In use, the lamp is aimed at the object to be studied at a distance determined by the area to be illuminated and the amount of light needed. The camera (any ordinary type with "X" flash synchronization) and photoelectric pickoff are connected to the control unit and the controls set until the motion appears stopped at the right point. Set the Strobolume for single flash, operate the shutter, and you have a picture. When not in use, all parts of the Strobolume are stored and carried in a compact Flip-Tilt case that protects the equipment from dust and damage.



1540 Strobolume shown with lamp head and all three available control units.

## Type 1531-P2 FLASH DELAY

- synchronize GR stroboscopes for high-speed photography with most cameras controlled visual inspection
- stop motion at any point in cycle

The 1531-P2 permits GR stroboscopes to be synchronized with moving objects and provides control of the flash occurrence relative to the position of the object by introducing a variable time delay between the position-sensing transducer (photo cell) and the stroboscope. This permits all phases of the motion to be studied. For photography, the camera shutter, the motion of the subject, and the strobe flash can all be synchronized.

### specifications

**Time-Delay Range:** Approx 100  $\mu$ s to 0.8 s in three ranges.

**Output Pulse:** Better than 13 V available for triggering the 1531-A and 1538-A Strobotac electronic stroboscopes and the 1539-A Stroboslave.

**Sensitivity:** As little as 0.3-V input will produce sufficient output to trigger the stroboscope.

**Inputs:** Phone jacks for triggering; jack for camera synchronization.

**Accessories Supplied:** Trigger cable with pushbutton, phone-plug adaptor, carrying case.



With the pickoff, one can view and photograph moving objects having variable or unsteady speeds.

The flash delay is a valuable accessory to the 1531 Strobotac® electronic stroboscope as it amplifies and conditions the triggering pulse for reliable operation from external triggers. It will also drive the 1538-A Strobotac and the 1539-A Stroboslave® stroboscopic light source. — See *GR Experimenter* for August 1963.

**Accessories Available:** 1536-A Photoelectric Pickoff.

**Power Required:** 105 to 125 or 210 to 250 V, 50 to 400 Hz, 5 W with 1536-A connected.

**Mounting:** Aluminum case with bracket, which clips directly onto the Strobotac electronic stroboscope.

**Dimensions (width x height x depth):** 5 1/4 x 3 3/4 x 3 3/4 in. (135 x 80 x 96 mm).

**Weight:** Net, 2 lb (1 kg); shipping, 5 lb (2.3 kg).

Catalog Number	Description
1531-9602	1531-P2 Flash Delay

## Type 1536-A, Type 1537-A PHOTOELECTRIC PICKOFFS



These photoelectric pickoffs produce an output when the photosensitive element senses a change in light such as would be produced by a piece of reflective tape on a moving object. If the resulting pulse is used to trigger a stroboscope, the flashes will occur in synchronism with the motion and permit the object to be viewed or photographed as though stationary.

The 1536-A pickoff can be used with either the 1531-P2 Flash Delay and 1531 Strobotac® electronic stroboscope or the 1540-P4 Oscillator/Delay and 1540 Strobolume® electronic stroboscope for applications requiring control of the time of occurrence of the flash relative to the position of the moving object. The 1536 contains, in addition

- optical triggering of GR stroboscopes
- small, maneuverable, sturdy mounting
- triggering rate up to 150,000 rpm

to its photocell and lens, a light source that requires power.

The 1531-P2 and 1540-P4 contain the power supplies for the 1536-A, plus the additional circuitry to amplify and shape the output for positive operation of the stroboscopes and to permit a time delay to be introduced between the pickoff and the stroboscope.

The 1537-A pickoff will directly trigger the 1538-A, 1539-A, 1540-P1, 1540-P3, or 1540-P4 (not the 1531), but, lacking a built-in lamp, the pickoff must be triggered from a strong external light source.

— See *GR Experimenter* for April 1966.

### specifications

#### 1536-A

**Operating Rate:** Approx 2500 pulses/s as limited by the 200- $\mu$ s time constant of the photocell and cable combination.

**Power Required:** 20 to 200 V dc, 40 mA. Power is supplied by the 1531-P2 Flash Delay or 1540-P4 Oscillator/Delay.

#### 1537-A

**Operating Rate:** Greater than 2500 pulses/s.

**Power Required:** 3 to 25 V dc; 0 to 100  $\mu$ A depending on operating rate. Power is supplied by instrument with which it is used.

#### GENERAL

**Accessories Supplied:** 10-ft roll of 3/8-in. black tape; 10-ft roll of 3/8-in. silver tape; carrying case.

**Mounting:** C-clamp (capacity 1 1/4-in., flat or round) or 1 1/2-in. magnet, both supplied.

**Dimensions:** Pickoff head, 1 1/4-in. dia, 2 in. long. Linkage consists of two 3/4-in. diameter stainless-steel rods, 6 and 6 1/4 in. long, and adjustable connecting clamp. Cable is 8 ft long, terminated in phone plug.

**Weight:** Net, 1 1/4 lb (0.6 kg); shipping, 4 lb (1.9 kg).

Catalog Number	Description
1536-9701	1536-A Photoelectric Pickoff
1537-9701	1537-A Photoelectric Pickoff

## specifications

### FLASHING-RATE RANGES

**Internal:** With 1540-P1 Oscillator, 110 to 25,000 flashes per minute; control calibrated with 1% accuracy. With 1540-P4 Oscillator/Delay, approx 30 to 25,000 flashes per minute in 3 overlapping decade ranges; uncalibrated control.

**External:** 0 to 25,000 flashes per minute.

### LIGHT OUTPUT CHARACTERISTICS

**Intensity at max beam width (intensity increases as beam narrows):**

Range	Flash Rate (per minute)	Approximate Guide Number for ASA 160 Ektachrome
Low	0 to 700	70
Medium	0 to 4200	28
High	0 to 25,000	11

Auxiliary input provided for booster capacitor to increase single-flash intensity.

**Flash Duration:** 15  $\mu$ s in low range, 12  $\mu$ s in medium, 10  $\mu$ s in high.

**Beam Width:** 7 $\frac{1}{2}$  x 13 feet at 10-foot distance (40° x 65°); can be narrowed by internal adjustment to 3 x 13 ft (17° x 65°).

### ELECTRICAL TRIGGERING

**External Input:** All control units will operate from a front-panel pushbutton, GR Photoelectric Pickoffs (the -P1 and -P3 operate from the 1537 only, the -P4 from the 1536 or 1537 pickoff), a contact closure (and/or opening for the -P4), or from a positive pulse of  $\geq 1$  V. The 1540-P4 will also trigger from a sine wave of  $\geq 0.35$  V rms, the -P1 from a sine wave of  $\geq 0.35$  V rms from 25,000 to 6000 per minute increasing to  $\geq 3.5$  V rms at 300 per minute.

**Output Trigger (1540-P1 and -P4):**  $>6$ -V positive pulse behind 600  $\Omega$ .

### OSCILLATOR/DELAY CONTROL UNIT (1540-P4)

**Delay:** Time from external trigger to flash continuously adjustable approx 100  $\mu$ s to 1 s in 3 overlapping ranges. Control uncalibrated.

**Multiflash Mode:** Flash bursts as long as front-panel pushbutton is depressed or contact closure exists at CAMERA input jack. Flashing rate set by panel controls.

**Camera Input:** "X" contact closure of camera causes either undelayed flash at instant of contact closure, or delayed flash synchronized to subject by external trigger signal.

### GENERAL

**Remote Programming:** Strobolume can be controlled by external signals in place of any control unit. Intensity/range control by grounding through 28-V 60-mA rated switch contacts. Frequency control: flash triggered by positive pulse  $\geq 0.75$  V.

**Cables:** 12-foot flat multiconductor cable connects lamp head to power supply; extension cables available on special order. 6-foot cable supplied permits separation between lamp head and control unit.

**Accessories Supplied:** Adjustable neck strap, phone plug for input/output jacks, 6-ft cable for remote connection between lamp head and control unit.

**Accessories Available:** Control units 1540-P1, -P3, or -P4 (one required); the 1540-P2 lamp-head assembly with adjustable neck strap and handle; 1540-P5 Replacement Stroboltron Flash Lamp with a glove to protect quartz lamp during installation; 1536-A and 1537-A Photoelectric Pickoffs. Cables for extra separation between power supply, lamp head, and control unit are available on special order.

**Power Required:** 100 to 125, or 195 to 250 V, 50 to 400 Hz, 250 W.

**Mounting:** Flip-Tilt case contains power supply and storage compartment for lamp head, one control unit, and cables.

**Dimensions (width x height x depth):** Case (closed), 19 x 8 x 13 $\frac{1}{4}$  in. (495 x 205 x 350 mm). Lamp head with control unit attached, 9 $\frac{1}{4}$  x 5 $\frac{1}{2}$  x 8 $\frac{1}{2}$  in. (235 x 140 x 220 mm).

**Weight:** Net, 36 lb. (16.5 kg); shipping, 41 lb. (19 kg); lamp head and 1 control unit, 6 lb. (2.8 kg), net.



The Strobolume is ideal for synchronized, single-flash high-speed photography—even in color. For example, the 1540 has a guide number of 70 when used with High-Speed Ektachrome (ASA 160).

Catalog Number	Description
1540-9600	<b>1540 Strobolume electronic stroboscope</b> Requires one of following control units: <b>1540-P1 Strobolume Oscillator</b>
1540-9601	<b>1540-P3 Strobolume Control Unit</b>
1540-9603	<b>1540-P4 Oscillator/Delay Unit</b>
1540-9604	<b>1540-P2 Strobolume Lamp (assembly)</b>
1540-9602	<b>1540-P5 Replacement Stroboltron Flash Lamp</b>
1540-9605	



## Type 1541 MULTIFLASH GENERATOR

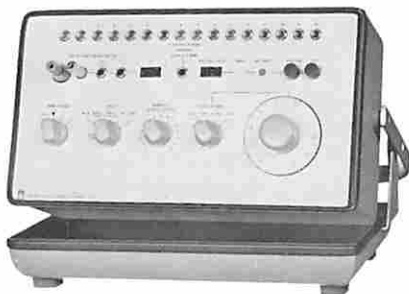

**There's been nothing like it before!** The 1541 Multiflash Generator is a photographic tool that expands the versatility of existing strobes and high-speed photographic setups to new levels of resolution and accuracy. Yet, it is a simple device and does not complicate the acquisition of photographic data.

Strobe light offers several advantages to the photographer: Microsecond light is the shutter, which reduces blurs and distortion.

The high-speed event, the camera, and the light are easily synchronized for exposure at the right moment.

The strobe is a cool light-source—it is off except during the instant of exposure.

Information content of the resulting photos can be increased by multiple-exposure techniques.

The 1541 is useful with still, conventional movie (ciné), and high-speed movie cameras. An input trigger consisting of an opening or closing contact, a positive or negative electrical signal, or a light-to-dark or dark-to-light contrast change sensed by a photocell can be used to indicate the subject is in the desired position and to initiate the flash or flashes. A panel TEST button simulates an input signal for system checking.

With a still or ciné camera, a single flash-per-frame exposure can be made, even if the subject is repetitive, and the subject's image can be electrically repositioned for exposure, if desired. Or a multiple exposure can be made with the advantage that information about the subject at several points in time and space is shown with respect to each other which greatly simplifies data reduction. Such photographs are easily obtained with this inexpensive system and can yield data that would otherwise be unobtainable or would require expensive ultra-high-speed movie equipment. As Polaroid\* film is often employed, material and processing times can be drastically reduced.

For multiflash photos a single strobe can be flashed from 2 up to 16 times in response to the input trigger from the

\*Registered trademark of the Polaroid Corp.

- a true flash-burst trigger generator
- increases the effective flash rates of available strobes to 100,000 per second
- both an accurately calibrated flash delay and a flash time-interval source—makes your photographic setup an accurate sampling system
- synchronizes strobes for still, ciné, and high-speed movie applications

subject. The number of flashes in the burst and the separation between flashes are determined by front-panel control settings; the maximum burst frequency is limited by the strobe and its settings. Alternatively, 1 to 16 strobes can be single-flashed in sequence on their highest-intensity settings (for greatest depth of field) at up to 100,000 flashes per second. The rate is adjustable to an accuracy of  $\pm 3\%$ ; an electronic counter (not supplied) can be used if greater accuracy is required. The separation between flashes in the burst can be non-equal to photograph more effectively subjects with rapidly changing speeds. Multiple strobes can be distributed along the subject trajectory for better utilization of the available light and can be used with various color filters to aid in successive image discrimination.

**Simple strobes for complex tasks** The 1541 extends the flash rates of small, inexpensive, lightweight strobes for high-speed movie work. Several strobes are sequence-flashed to multiply effectively the frequency of the output light. For example, the use of 16 Type 1538 Stroboatac® electronic stroboscopes can continuously produce  $16 \times 2,500$  or 40,000 flashes per second, about the upper limit for today's high-speed movie cameras.

The number and type of strobes used will depend on the requirements for light-per-flash, flash rate, and allowable duration. We recommend the inexpensive type 1539 StroboSlave® stroboscopic light source for small, high-speed subjects. Where more light is required, particularly for larger areas, the 1540 with 20 times the light output is suggested. The 1538 is excellent when the highest flash rate is required.

When you specify a strobe, consider the advantage of including one or more general-purpose strobes with the 1541 to have them available, at minimum additional cost for numerous other applications in the laboratory. Considerable applications\* information is contained in two publications, *The Handbook of High-Speed Photography* (\$1.00) and *The Handbook of Stroboscopy* (\$2.00), available from General Radio Company.

### specifications

**Modes:** Continuous, internal oscillator continuously runs either single or multiple strobes at a rate set by panel controls. Calibration, continuous calibration signal available at rear phone jack for use with electronic counter. **Burst on arm and input:** each input trigger initiates a flash burst. **Burst on arm and input:** only one flash burst is produced by a trigger signal following an input arming signal to prevent unwanted bursts due to spurious input signals; input is armed by panel pushbutton or external contact closure, such as a switch or shutter contact; panel lamp indicates armed or unarmed condition. **Movie:** one sequenced output pulse is produced for each input pulse; the number of pulses in the sequence can be 2 to 16 as determined by panel control.

**Input Trigger:** for subject or event sync; Contact opening, contact closure,  $\pm 1$ -V pulse, light-to-dark or dark-to-light transition from 1536 Photoelectric Pickoff.

**Output Trigger:**  $\pm 20$  V behind 60  $\Omega$ . To single strobe, 2 to 16 equally-spaced pulses, switch selectable. To separate strobes, 1 to 16 equally-spaced pulses, switches determined by number of strobes used and panel control; separation between pulses (time base) can be varied by shifting output jacks.

**Flash Interval:** Range, 100 ms to 10  $\mu$ s (10 to 100,000 flashes per second) in 4 overlapping decade ranges. Accuracy,  $\pm 3\%$  of reading + 800 ns.

**Supplied:** 1541-9601 6-ft cable terminated in phone plugs for connection of output to strobe, cable-mounted remote arming switch, and power cord.

**Available:** 1531, 1538, 1539, 1540 stroboscopes, 1563 photoelectric pickoff with built-in light source, 1541-9601 6-ft output cables, 1560-P76 3-ft output cables, 1152 counter.

**Power:** 100 to 125 and 200 to 250 V, 50-60 Hz.

**Mechanical:** Flip-Tilt case. Dimensions (w x h x d): 14 x 10 x 6.69 in. (356 x 254 x 170 mm).

Catalog Number	Description
1541-9701	1541 Multiflash Generator